

# **ebele**<sup>®</sup>

**Oliekeerringen**

**O-ringen**

**V-ringen**

**Quad-ringen**

**Bonded-seals**

**Afstrijkers**

**Eindkappen**

**Gamma ringen**

**Speedi Sleeves**

**Borgringen**

**Nilos-ringen**

## **AFDICHTINGEN**

## Inhoudsopgave

	Bladzijde		Bladzijde
Oliekeerringen equivalent tabel	1	O-ring assortimentdozen	46
Materialen + technische gegevens	2	Back-up ringen	47
VR radiale Lipafdichting	4	Teflon O-ringen	47
Oliekeerringen met rvs huis - teflonlip	5	Meetkegels	48
Speciaal montage vet	5	Precisie Quad-ringen	50
SEAL JET oliekeerringen	5	Vuilafstrijkers	51
Assortiment NBR oliekeerringen	6	V-ringen	55
Assortiment FPM oliekeerringen	21	Usit-ringen, bonded seals	60
Opmerkingen oliekeerringen	20	Eindkappen	61
Oliekeerringen GWBM	24	Gamma ringen	62
Precisie O-ringen	25	Speedi sleeves	64
Groefafmetingen O-ringen	26	Borgringen	65
NBR O-ringen	27	Nilosringen	69
FPM O-ringen	38	Overzicht manchetten	70
O-ring snoer	45	Omrekeningstabel inch maten	77
O-ringkit Loctite	45		

## Ebele bv Rotterdam

Plompertstraat 34, 3087 BD Rotterdam

Postbus 5100, 3008 AC Rotterdam

Telefoon 010 - 429 36 55

Telefax 010 - 429 97 89



## Oliekeerringen volgens DIN 3760 NBR - FPM

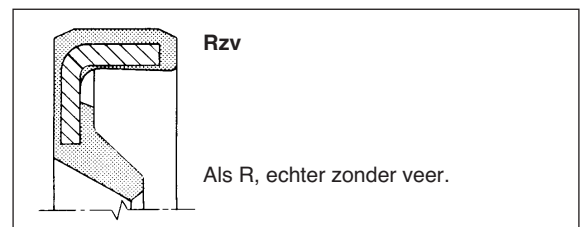
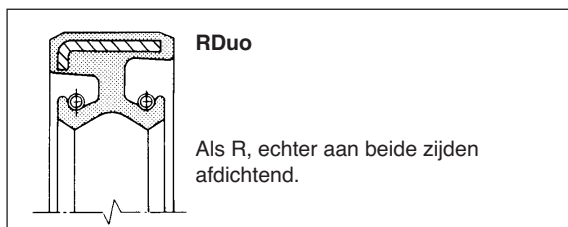
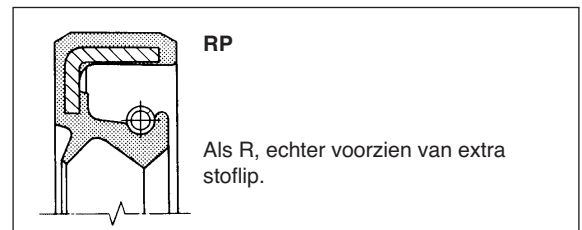
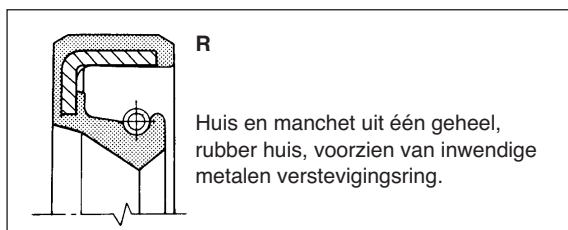
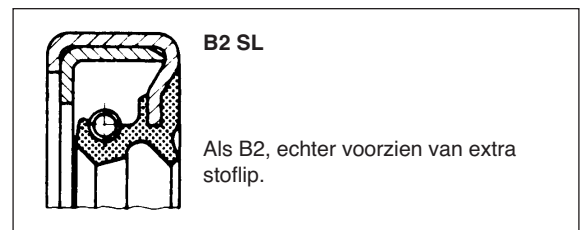
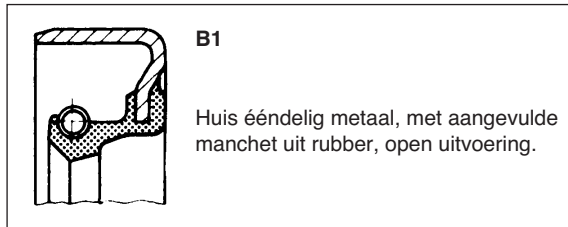
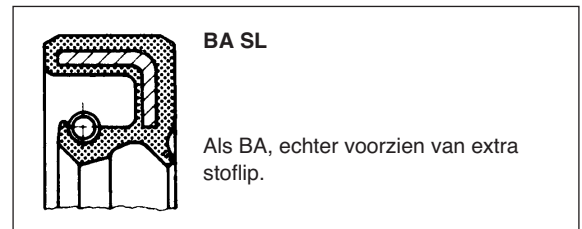
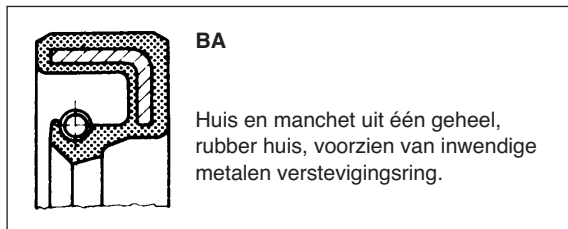

### Oliekeerringen equivalent tabel

<b>ebele</b>	R	RP	Rzv	RDuo	B1	B1SL	B2	B2SL
Freudenberg-Simrit	BA	BASL	BAOF	BADUO	B1	B1SL	B2	B2SL
Goetze	827N	827S	827NO	827D	822N	822S	824N	824S
Stefa	CB	CC	CD	CK	BB	BC	DB	DC
Gaco	A	FA	SA	DUPLEX	ABI			
Pioneer Weston	R21	R23	R26	R22	R4	R6	R1	
Chicago Rawhide					CRW1	CRWA1	CRWH1	CRWHA1
National	35	32			48	47	45	41
NAK	SC	TC	VC	DC	SB	TB	SA	TA
Dichtomatik	WA	WAS	WAO	WAD	WB	WBS	WC	WCS
Ringseal	A	AS	AOF	AD	B	BS	C	CS
Eriks	R	RST	RZV	RDuo	M	MST	GV	GVST

---

## Materialen

De standaard oliekeerringen volgens DIN 3760 bestaan uit een ongelegeerde koolstofstalen versterkingsring met meestal daaromheen een rubber buitenmantel uit verschillende compounds.

Elk van deze compounds (rubbersamenstelling), heeft zijn eigen temperatuurbereik en media bestendigheid.

Kwaliteit	Basismateriaal	Hardheid	Temperatuurbereik	Bestand tegen o.a.
NBR	Nitrilbutadeen	70 ± 5	- 40 + 100	Minerale olie en vetten, water, alcohol, acetyleen
FPM	Fluorkoolstof elastomeer	75 ± 5	- 30 + 200	Synthetische en hydraulische vloeistof, zoutzuur, dieselolie, benzine

---

## Druk

De standaard oliekeerring is in principe een drukloze afdichting, bestemd voor een roterende niet axiaal schuivende as. Door gebruik te maken van een steunring (zie tekening) die aan het profiel van de dichtlip is aangepast, kan de oliekeerring worden toegepast tot 0.5 bar. Voor hogere drukken zijn momenteel speciale oliekeerringen verkrijgbaar die een druk tot 10 bar kunnen verdragen (zie Elring).

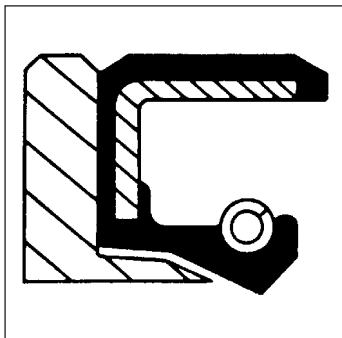

## Smering

Een adequate smering tussen as en dichtlip is essentieel voor de levensduur van een oliekeerring echter door de bewegingsvorm moeilijk te verkrijgen.

Bij de meest voorkomende toepassingen als olie of vetkeerring is de smering verzorgd. In andere gevallen moet er een smeermiddel worden toegepast (zie ons speciaal vet op pagina 5).

Als de te dichten vloeistof geen goede smeereigenschappen heeft (o.a. water), dan maakt men veel gebruik van de RP of RDuo oliekeerring. De ruimte tussen de twee lippen kan dan met vet gevuld worden. In andere gevallen moet men nasmeren.

## De as en het huis

Ook de asafwerking en de hardheid van de as zijn twee belangrijke factoren voor de levensduur van een oliekeerring. Een as met een hardheid van HRC 45 en een tolerantie volgens ISO h11 is het meest geschikt voor de standaard oliekeerring. De buisboring is minimaal volgens ISO H8. Zowel de as als het huis dienen aan een zeer hoge oppervlakte gladheid te voldoen.

## Montage

1. Check voor montage of as en huis schoon en braamvrij zijn.
2. Gebruik een montagebus indien de oliekeerring bijvoorbeeld over een spiebaan geschoven moet worden.
3. Smeer dichtlip en as in met schoon vet of olie. Indien RP of RDuo wordt gemonteerd, de ruimte tussen de beide lippen vullen met vet.
4. De oliekeerring gelijkmatig met gebruik van een hulpstuk op zijn plaats brengen.
5. De dichtlip altijd naar de af te dichten vloeistof plaatsen.

## VR Radiale Lipafdichting type BSB

Voor onderhoud en revisie is nu de VR Radiale Lipafdichting type BSB leverbaar. Deze kan direct na het uitnemen van de oude versleten oliekeerring en zonder nabehandeling van de as gemonteerd worden. Hierbij is het niet belangrijk of de oude afdichting inloossporen achtergelaten heeft of niet. Slechts verontreinigingen en scherpe kanten dienen verwijderd te worden. De VR Lipseal type BSB heeft een contactlijn met de as, die niet op dezelfde plaats gesitueerd is als die van de traditionele oliekeerring.

Het type BSB heeft daarnaast het voordeel dat de afdichting zonder hulp van een inpersdoorn of soortgelijke hulpstukken gemakkelijk met de hand gemonteerd kan worden. Door de elastische gummi buitenwand welke een overmaat van 0,3 tot 0,4 mm heeft ten opzichte van de H8 passing, worden ook oneffenheden van de passing en eventuele kleine beschadigingen van de oorspronkelijke afdichtingen uitgevlakt en dicht de afdichting ook over de statische buitenomtrek perfect af. Tevens zijn alle voordelen van de andere typen VR Lipseals bewaard gebleven, zoals het geen pompeffekt hebben, het kunnen opvangen van een rondloopafwijking tot 0,4 mm, drukvast tot 10 bar. etc.

De BSB afdichting zal de gebruiker veel kosten besparen. Zowel door het overbodig worden van dure nabewerkingen van de as als door de enorme besparing op manuren tijdens het onderhoud.

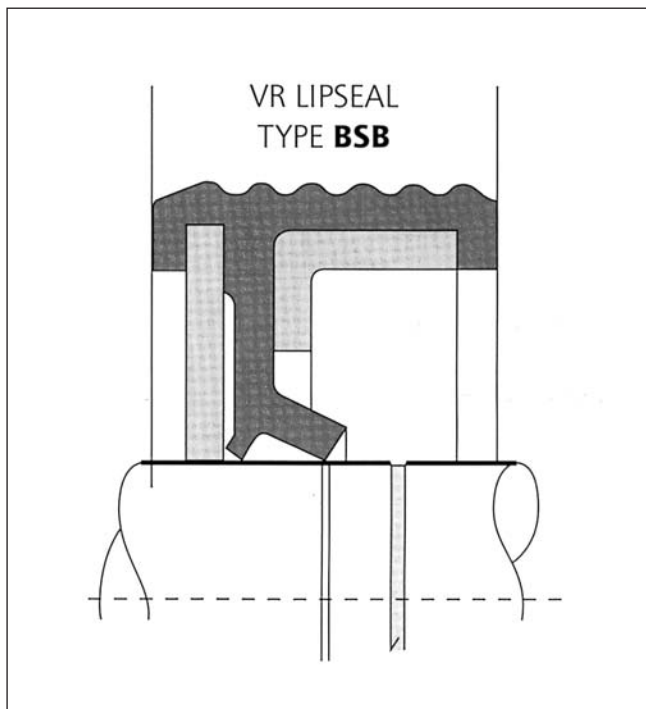

De standtijd van de BSB is een veelvoud langer dan die van de oliekeerring. Na vervanging van de eerste oliekeerring door eenzelfde oliekeerring valt de standtijd terug naar slechts 50% van de originele standtijd in verband met het reeds ontstane inloosspoor. Wordt daarna de afdichting nogmaals gewisseld, dan valt de standtijd terug naar circa 30% van de originele standtijd. Echter bij montage van een type BSB afdichting na de eerste versleten oliekeerring, kan de standtijd zelfs verdrievoudigd worden ten opzichte van de originele oliekeerring standtijd. Dit effect wordt bereikt doordat het contactvlak van de afdichting is verlegd en ook doordat de radiaalcracht van de dichtklep op de as slechts 1/3 tot 1/4 van de radiaalcracht van een oliekeerring is. Deze gegevens gelden voor standaard gebruiksomstandigheden.

Het nieuwe type BSB is leverbaar in de uitvoeringen met Nitrilemembraan en RVS steundelen en met Viton® membraan en RVS steundelen.

Zoals geschetst is het type BSB een duidelijke stap op weg naar een zo efficiënt mogelijk productieproces, waarbij een vermindering van onderhoud en een reductie van kosten een belangrijke rol spelen. Afdichtingen zullen in de verschillende processen een steeds belangrijker plaats innemen. Hierbij zullen VR Radiale Lipafdichtingen een steeds voornamere rol gaan spelen en waarborgen een continu productieproces over een langere periode.

### Matenlijst VR Radiale lipafdichtingen

5 x 16 x 7	24 x 40 x 7	52 x 68 x 8
6 x 16 x 7	24 x 47 x 7	52 x 72 x 8
6 x 22 x 7	25 x 35 x 7	55 x 70 x 8
7 x 22 x 7	25 x 40 x 7	55 x 70 x 10
8 x 22 x 7	25 x 42 x 7	55 x 72 x 8
8 x 24 x 7	25 x 47 x 7	55 x 72 x 10
9 x 22 x 7	25 x 52 x 7	55 x 80 x 8
9 x 24 x 7	26 x 37 x 7	55 x 85 x 8
9 x 26 x 7	26 x 42 x 7	56 x 70 x 8
10 x 22 x 7	26 x 47 x 7	56 x 72 x 8
10 x 24 x 7	28 x 40 x 7	56 x 80 x 8
11 x 26 x 7	28 x 47 x 7	56 x 85 x 8
11 x 22 x 7	28 x 52 x 7	58 x 72 x 8
11 x 26 x 7	30 x 40 x 7	58 x 80 x 8
12 x 22 x 7	30 x 42 x 7	60 x 75 x 8
12 x 24 x 7	30 x 47 x 7	60 x 80 x 8
12 x 28 x 7	30 x 50 x 7	60 x 85 x 8
12 x 30 x 7	30 x 52 x 7	60 x 85 x 10
14 x 24 x 7	30 x 62 x 7	60 x 90 x 8
14 x 28 x 7	32 x 45 x 7	62 x 85 x 10
14 x 30 x 7	32 x 47 x 7	62 x 90 x 10
14 x 35 x 7	32 x 52 x 7	63 x 85 x 10
15 x 26 x 7	35 x 47 x 7	63 x 90 x 10
15 x 30 x 7	35 x 50 x 7	65 x 85 x 10
15 x 32 x 7	35 x 52 x 7	65 x 90 x 10
15 x 35 x 7	35 x 62 x 7	65 x 100 x 10
16 x 28 x 7	36 x 47 x 7	68 x 90 x 10
16 x 30 x 7	36 x 50 x 7	68 x 100 x 10
16 x 32 x 7	36 x 52 x 7	70 x 90 x 10
16 x 35 x 7	36 x 62 x 7	70 x 100 x 10
17 x 28 x 7	38 x 52 x 7	72 x 95 x 10
17 x 30 x 7	38 x 55 x 7	72 x 100 x 10
17 x 32 x 7	38 x 62 x 7	75 x 95 x 10
17 x 35 x 7	40 x 52 x 7	75 x 100 x 10
17 x 40 x 7	40 x 55 x 7	78 x 100 x 10
18 x 30 x 7	40 x 62 x 7	80 x 100 x 10
18 x 32 x 7	40 x 72 x 7	80 x 110 x 10
18 x 35 x 7	42 x 55 x 8	85 x 110 x 10
18 x 40 x 7	42 x 62 x 8	85 x 120 x 12
20 x 30 x 7	42 x 72 x 8	90 x 110 x 12
20 x 32 x 7	45 x 60 x 8	90 x 120 x 12
20 x 35 x 7	45 x 62 x 8	95 x 120 x 12
20 x 40 x 7	45 x 65 x 8	95 x 125 x 12
20 x 47 x 7	45 x 72 x 8	100 x 120 x 12
22 x 32 x 7	48 x 62 x 8	100 x 125 x 12
22 x 35 x 7	48 x 72 x 8	100 x 130 x 12
22 x 40 x 7	50 x 65 x 8	105 x 130 x 12
22 x 47 x 7	50 x 68 x 8	105 x 140 x 12
24 x 35 x 7	50 x 72 x 10	110 x 130 x 12
24 x 37 x 7	50 x 80 x 8	110 x 140 x 12

## Oliekeerringen met roestvaststalen huis en Teflon dichtlip

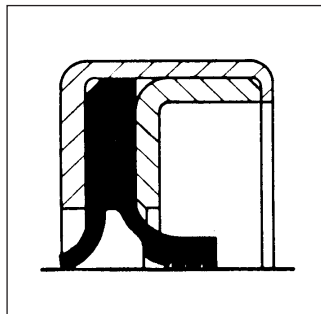

HN 2580

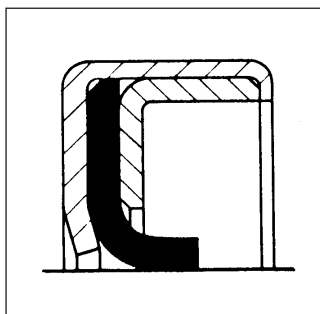

HN 2390

	HN 2580	HN 2390
max. druk	0,2 bar	10 bar
max. snelheid	30 m/sec	20 m/sec
temperatuurbereik	-60°C +220°C	-60°C +200°C
PTFE soort	HS 17608	HS 21037
dichtlip	met stoflip	zonder stoflip
		met rugversterking
mantel	RVS 1.4301	RVS 1.4301
as	moet gehard zijn	mag ongehard zijn
smering	moet aanwezig zijn	mag drooglopen
chem. bestendigheid	zeer goed	zeer goed

Eriks type: PS  
CFW type: B2PT

Aan oliekeerringen worden steeds hogere eisen gesteld. De vraag naar een groter temperatuurbereik, een bestendigheid tegen de meest voorkomende chemische stoffen, een hoger toelaatbaar toerental en hogere drukkbestendigheid komt steeds meer voor.

Elring ontwikkelde een tweetal oliekeerringen om aan al deze eisen tegemoet te komen.

De oliekeerring met een roestvaststalen huis en een Teflon dichtlip voldoet aan zeer hoge eisen, zoals blijkt uit bovenstaand overzicht.

10 x 22 x 7*	25 x 40 x 7	35 x 62 x 8	55 x 80 x 8	90 x 120 x 12
10 x 24 x 7	25 x 42 x 7*	40 x 52 x 8*	55 x 80 x 10	95 x 120 x 12*
10 x 28 x 7	25 x 42 x 8*	40 x 55 x 8*	60 x 75 x 8	100 x 120 x 12
12 x 22 x 7	25 x 42 x 10*	40 x 55 x 10	60 x 80 x 8*	100 x 125 x 12*
12 x 24 x 7	25 x 47 x 7*	40 x 60 x 8*	60 x 80 x 10*	100 x 130 x 12*
12 x 28 x 8*	28 x 47 x 7	40 x 62 x 8*	60 x 82 x 12	100 x 130 x 13*
12 x 30 x 7	30 x 40 x 7*	40 x 72 x 10	65 x 85 x 8*	105 x 130 x 12*
15 x 26 x 7	30 x 42 x 7*	45 x 62 x 8*	65 x 90 x 10	110 x 130 x 12*
15 x 30 x 8*	30 x 45 x 7	45 x 62 x 10*	70 x 90 x 10*	110 x 140 x 12
15 x 32 x 7	30 x 47 x 7*	45 x 65 x 8	70 x 95 x 10	120 x 140 x 10
15 x 35 x 7	30 x 47 x 10*	45 x 65 x 10*	70 x 100 x 10	120 x 150 x 12
18 x 30 x 7*	30 x 50 x 7	45 x 68 x 12	75 x 95 x 10	130 x 155 x 10*
20 x 30 x 7	30 x 50 x 10*	45 x 80 x 8	75 x 100 x 10*	130 x 160 x 12
20 x 32 x 7	30 x 52 x 7	50 x 65 x 8*	80 x 100 x 10*	135 x 160 x 12
20 x 35 x 7*	35 x 47 x 7	50 x 65 x 10*	80 x 110 x 10	140 x 165 x 12*
20 x 40 x 7*	35 x 47 x 8*	50 x 68 x 8	85 x 100 x 8*	150 x 180 x 12
20 x 42 x 10	35 x 50 x 8*	50 x 70 x 10*	85 x 105 x 13*	160 x 190 x 15
20 x 47 x 7	35 x 50 x 10*	50 x 72 x 8*	85 x 110 x 10*	
24 x 40 x 7	35 x 52 x 8	55 x 72 x 8*	85 x 120 x 12	
25 x 35 x 8*	35 x 55 x 8	55 x 72 x 10	90 x 110 x 10	

De met \* gemerkte seals behoren tot het standaardprogramma en zijn op korte termijn leverbaar.

Prijzen - en levertijden van de overige types - verstrekken wij u graag op aanvraag.

### Synthetisch speciaal vet

Omdat de wrijvingscoëfficiënten van elastomeren op staal hoog zijn, levert dit problemen op bij de montage van o.a. O-ringen, oliekeerringen en manchetten.

In de praktijk worden veel afdichtingen droog gemonteerd, waardoor reeds vanaf de montage beschadigingen ontstaan.

Door de te monteren afdichtingen licht in te vetten met Kluber vet Silubrin Grease I, voorkomt u dit probleem.

Prijzen en meer technische informatie omtrent deze Kluber vetsoort verstrekken wij u graag op aanvraag.

### Seal Jet oliekeerringen

Door gebruik te maken van de computergestuurde Seal Jets kunnen wij in veel gevallen haast elke oliekeerring uit diverse verschillende materialen zoals o.a. Teflon, silicone, polyurethane en NBR tot 530 mm buitendiameter op maat voor u maken.

Ook standaard oliekeerringen voorzien van een grotere uitwendige diameter of het samenstellen van een dubbelwerkende oliekeerring behoort tot de mogelijkheden.

Vraag hiervoor onze speciale Seal Jet profielenlijst.

Prijzen verstrekken wij u graag op aanvraag.

## Oliekeerringen NBR DIN 3760

d	D	h	type	d	D	h	type	d	D	h	type
3	x 10	x 6	BAof	8	x 24	x 7	R	12	x 19	x 5	R
4	x 8	x 2	Rzv	8	x 26	x 8	R*	12	x 20	x 4	R
4	x 9	x 3	Rzv	8	x 30	x 7	R	12	x 20	x 5	B1
4	x 11	x 6	BA	9	x 13	x 3	Rzv	12	x 20	x 5	RP
4	x 11	x 6	R	9	x 16	x 3	Rzv	12	x 20	x 7	R
4	x 12	x 6	BA	9	x 18	x 7	R	12	x 21	x 3	Rzv
4	x 12	x 6	R	9	x 20	x 6	RP	12	x 21	x 4	R
5	x 9	x 2	Rzv	9	x 22	x 7	R	12	x 22	x 4	R
5	x 10	x 2	Rzv	9	x 24	x 7	R	12	x 22	x 4	Rzv
5	x 15	x 6	R	9	x 26	x 7	R	12	x 22	x 5	R
5	x 16	x 6	R	9	x 30	x 7	R*	12	x 22	x 6	R
5	x 16	x 7	R	9.52	x 19.05	x 6.35	B1*	12	x 22	x 7	B1
5	x 22	x 8	BA	9.52	x 19.05	x 6.35	RP	12	x 22	x 7	R
6	x 10	x 2	Rzv	9.52	x 22.22	x 6.35	R	12	x 22	x 7	RP
6	x 12	x 2	Rzv	10	x 14	x 3	Rzv	12	x 22	x 8	B2
6	x 14	x 6	R	10	x 16	x 4	Rzv	12	x 24	x 4.5	R
6	x 15	x 4	R	10	x 17	x 3	Rzv	12	x 24	x 6	R
6	x 15	x 6	R*	10	x 18	x 5	R	12	x 24	x 6	RP
6	x 16	x 6	R	10	x 18	x 6	B1*	12	x 24	x 6.5	R*
6	x 16	x 7	BA	10	x 18	x 6	R	12	x 24	x 7	R
6	x 16	x 7	R	10	x 19	x 7	BA	12	x 24	x 7	RP
6	x 17	x 6	R	10	x 19	x 7	R	12	x 24	x 8	R*
6	x 19	x 6	BA	10	x 19	x 7	RP	12	x 25	x 4.5	RP
6	x 19	x 6	R	10	x 20	x 5	RP	12	x 25	x 5	R
6	x 19	x 7	R	10	x 20	x 6	BA	12	x 25	x 7	R*
6	x 22	x 7	BA	10	x 20	x 6	R	12	x 25	x 7	RP
6	x 22	x 7	R	10	x 20	x 7	RP	12	x 25	x 8	BA
6	x 22	x 7	RP	10	x 21	x 5	R	12	x 25	x 8	R
6	x 22	x 8	BA	10	x 22	x 6	R	12	x 26	x 7	R
6	x 22	x 8	R	10	x 22	x 7	BA*	12	x 26	x 7	RP*
6	x 22	x 10	R*	10	x 22	x 7	R	12	x 26	x 8	R
6.35	x 12.7	x 3.17	Rzv	10	x 22	x 7	RP	12	x 28	x 7	R
6.35	x 19.05	x 6.35	R	10	x 22	x 8	B2	12	x 28	x 7	RP
7	x 11	x 2	Rzv	10	x 22	x 8	R	12	x 28	x 8	RP
7	x 14	x 2	Rzv	10	x 24	x 7	BA	12	x 30	x 5	R*
7	x 15	x 5	R	10	x 24	x 7	R	12	x 30	x 7	R
7	x 16	x 7	BA	10	x 24	x 7	RP	12	x 30	x 7	RP
7	x 16	x 7	R	10	x 25	x 7	RP	12	x 30	x 10	BA
17	x 18	x 8	RP*	10	x 26	x 7	BA	12	x 30	x 10	R
17	x 19	x 6	R*	10	x 26	x 7	R	12	x 32	x 5	R
7	x 22	x 7	BA	10	x 26	x 7	RP	12	x 32	x 7	R
7	x 22	x 7	R	10	x 28	x 7	R	12	x 32	x 7	RP
7	x 22	x 8	R	10	x 30	x 7	R	12	x 32	x 8	R
7.93	x 19.05	x 6.35	B1*	10	x 30	x 8	R	12	x 32	x 10	R
8	x 12	x 3	Rzv	11	x 17	x 5	RP	12	x 35	x 7	RP
8	x 14	x 3	B1of	11	x 22	x 7	BA	12	x 35	x 10	R
8	x 14	x 4	R*	11	x 22	x 7	R	12	x 37	x 7	Rzv
8	x 15	x 3	Rzv	11	x 24	x 7	R	12	x 37	x 10	R*
8	x 15	x 5	R	11	x 26	x 6	R	12	x 40	x 7	R
8	x 16	x 7	BA	11	x 26	x 7	R	12.7	x 22.22	x 6.35	B1*
8	x 16	x 7	R	11	x 28	x 7	R	12.7	x 22.22	x 6.35	R
8	x 18	x 5	R	11	x 30	x 7	R	12.7	x 25.4	x 6.35	B1*
8	x 18	x 7	RP	11.11	x 25.4	x 7.93	B1*	12.7	x 25.4	x 6.35	RP
8	x 20	x 5	RP	11.11	x 28.58	x 9.52	B1*	12.7	x 25.4	x 9.52	B1*
8	x 20	x 7	R	12	x 16	x 3	Rzv	12.7	x 28.58	x 6.35	B1*
8	x 22	x 7	BA	12	x 18	x 3	Rzv	12.7	x 28.58	x 6.35	R
8	x 22	x 7	R	12	x 18	x 4	Rzv	12.7	x 28.58	x 7.93	B1*
8	x 22	x 7	RP	12	x 18	x 4.5	Rzv	12.7	x 28.58	x 7.93	R*
8	x 22	x 8	R	12	x 19	x 3	Rzv	12.7	x 28.58	x 9.52	B1*
8	x 22	x 8	R-DUO	12	x 19	x 5	BA	12.7	x 28.58	x 9.52	R



## Oliekeerringen NBR DIN 3760

d	D	h	type	d	D	h	type	d	D	h	type
13	x 19	x 3	Rzv	15	x 24	x 7	B1-DUO*	15.88	x 28.58	x 7.93	RP
13	x 22	x 4	R	15	x 24	x 7	R	15.88	x 28.58	x 9.52	B1*
13	x 22	x 5	B1	15	x 24	x 7	RP	15.88	x 28.58	x 9.52	R*
13	x 22	x 5	R	15	x 24	x 7	R-DUO	15.88	x 31.75	x 6.35	B1*
13	x 22	x 6	R*	15	x 25	x 5	R	15.88	x 31.75	x 6.35	R
13	x 22	x 7	RP*	15	x 25	x 6	R	15.88	x 31.75	x 7.93	B1*
13	x 25	x 5	R	15	x 25	x 7	RP	15.88	x 31.75	x 7.93	R*
13	x 25	x 7	RP	15	x 26	x 4.5	R	15.88	x 31.75	x 9.52	R*
13	x 26	x 7	BA	15	x 26	x 6	R	16	x 22	x 3	Rzv
13	x 26	x 7	R	15	x 26	x 7	B1	16	x 22	x 4	Rzv
13	x 28	x 7	RP	15	x 26	x 7	BA	16	x 24	x 3	Rzv
13	x 30	x 7	R	15	x 26	x 7	R	16	x 24	x 4	R
13	x 30	x 8	R	15	x 26	x 7	RP	16	x 24	x 5	R
13	x 30	x 10	R	15	x 27	x 7	R	16	x 24	x 6	B1*
13	x 22	x 7	R*	15	x 27	x 7	RP	16	x 24	x 7	R
13	x 35	x 10	R	15	x 28	x 5	R	16	x 25	x 3	Rzv
14	x 18	x 3	B1of*	15	x 28	x 7	B1	16	x 26	x 7	B1*
14	x 20	x 3	Rzv	15	x 28	x 7	R	16	x 26	x 7	R
14	x 20	x 5	Rzv	15	x 28	x 7	R-DUO	16	x 26	x 7	RP
14	x 21	x 3	Rzv	15	x 28	x 7	RP	16	x 28	x 7	B1
14	x 22	x 3	Rzv	15	x 30	x 4.5	R	16	x 28	x 7	BA
14	x 22	x 4	R	15	x 30	x 7	B1	16	x 28	x 7	R
14	x 22	x 4	Rzv	15	x 30	x 7	BA	16	x 28	x 7	RP
14	x 22	x 7	R	15	x 30	x 7	R	16	x 30	x 4.5	B1*
14	x 24	x 5	R	15	x 30	x 7	RP	16	x 30	x 4.5	R
14	x 24	x 6	R	15	x 30	x 8	B1*	16	x 30	x 7	B1SL*
14	x 24	x 7	B1*	15	x 30	x 8	R	16	x 30	x 7	BA
14	x 24	x 7	BA	15	x 30	x 10	B2	16	x 30	x 7	R
14	x 24	x 7	R	15	x 30	x 10	BA	16	x 30	x 7	RP
14	x 24	x 7	RP	15	x 30	x 10	R	16	x 30	x 10	BA
14	x 25	x 5	R	15	x 32	x 5.5	R	16	x 30	x 10	R
14	x 25	x 7	R	15	x 32	x 7	B1	16	x 32	x 6	R
14	x 25	x 7	RP	15	x 32	x 7	R	16	x 32	x 7	BA
14	x 26	x 7	BA	15	x 32	x 7	RP	16	x 32	x 7	R
14	x 26	x 7	R	15	x 32	x 10	B2	16	x 32	x 7	RP
14	x 28	x 7	B1	15	x 35	x 5	R	16	x 32	x 10	R
14	x 28	x 7	R	15	x 35	x 7	B1*	16	x 33	x 11	R*
14	x 28	x 7	RP	15	x 35	x 7	BA	16	x 35	x 7	R
14	x 28	x 8	RP	15	x 35	x 7	R	16	x 35	x 8	R*
14	x 30	x 7	BA	15	x 35	x 7	RP	16	x 35	x 10	B1
14	x 30	x 7	R	15	x 35	x 8	R	16	x 35	x 10	R*
14	x 32	x 5	R	15	x 35	x 8	RP	16	x 40	x 7	R*
14	x 32	x 7	RP	15	x 35	x 10	B2	16	x 40	x 10	R
14	x 35	x 7	BA	15	x 35	x 10	R	16	x 40	x 10	RP
14	x 35	x 7	R	15	x 35	x 10	RP*	17	x 23	x 3	Rzv
14	x 35	x 8	R	15	x 37	x 7	RP*	17	x 24	x 5	R
14	x 35	x 10	B1*	15	x 40	x 10	B2*	17	x 24	x 7	R
14	x 35	x 10	RP	15	x 40	x 10	BA	17	x 25	x 3	Rzv
14.28	x 25.4	x 6.35	B1*	15	x 40	x 10	R	17	x 25	x 4	R
14.28	x 28.58	x 6.35	B1*	15	x 42	x 7	R	17	x 26	x 6	R
14.28	x 28.58	x 9.52	B1*	15	x 42	x 8	RP*	17	x 27	x 7	R
14.28	x 28.58	x 9.52	R	15	x 42	x 10	B2	17	x 27	x 7	RP
14.28	x 31.75	x 9.52	R*	15	x 42	x 10	R	17	x 28	x 6	BA
15	x 21	x 3	Rzv	15.6	x 25	x 7	R*	17	x 28	x 6	RP
15	x 21	x 4	Rzv	15.88	x 25.4	x 4.76	RP*	17	x 28	x 7	B1
15	x 22	x 7	R	15.88	x 25.4	x 6.35	B1*	17	x 28	x 7	BASL*
15	x 23	x 3	Rzv	15.88	x 25.4	x 6.35	R	17	x 28	x 7	R
15	x 23	x 5	R	15.88	x 28.58	x 6.35	B1*	17	x 28	x 7	RP
15	x 24	x 5	R	15.88	x 28.58	x 6.35	R	17	x 28	x 8	R-DUO
15	x 24	x 7	B1	15.88	x 28.58	x 7.93	B1*	17	x 30	x 5	R

## Oliekeerringen NBR DIN 3760

d	D	h	type	d	D	h	type	d	D	h	type
17	x 30	x 5	Rzv*	18	x 35	x 7	R	20	x 32	x 5	R
17	x 30	x 6	R	18	x 35	x 7	RP	20	x 32	x 7	B1
17	x 30	x 7	B1	18	x 35	x 8	BA	20	x 32	x 7	BA*
17	x 30	x 7	R	18	x 35	x 8	R	20	x 32	x 7	R
17	x 30	x 7	RP	18	x 35	x 10	B2*	20	x 32	x 7	RP
17	x 30	x 8	R	18	x 35	x 10	BA	20	x 32	x 8	RP*
17	x 30	x 8	RP	18	x 35	x 10	R	20	x 33	x 9	R
17	x 32	x 6	R	18	x 38	x 5	R	20	x 34	x 7	R*
17	x 32	x 7	BA*	18	x 40	x 7	R	20	x 34	x 7	RP
17	x 32	x 7	R	18	x 47	x 10	RP*	20	x 35	x 4	R
17	x 32	x 7	RP	19	x 27	x 4	Rzv	20	x 35	x 5	R
17	x 32	x 10	R	19	x 27	x 6	R	20	x 35	x 6	BA
17	x 34	x 4	R	19	x 30	x 7	R	20	x 35	x 6	R
17	x 34	x 7	R*	19	x 30	x 7	RP*	20	x 35	x 7	B1
17	x 34.5	x 4	R*	19	x 32	x 6	R	20	x 35	x 7	BA
17	x 35	x 5	Rzv*	19	x 32	x 7	B1	20	x 35	x 7	R
17	x 35	x 7	BA*	19	x 32	x 7	R	20	x 35	x 7	RP
17	x 35	x 7	R	19	x 32	x 7	RP*	20	x 35	x 8	B1
17	x 35	x 7	RP	19	x 32	x 10	R*	20	x 35	x 8	BA
17	x 35	x 8	R	19	x 35	x 6	R	20	x 35	x 8	R
17	x 35	x 8	RP	19	x 35	x 7	R	20	x 35	x 8	RP
17	x 35	x 10	BA	19	x 35	x 8	RP	20	x 35	x 10	B2
17	x 35	x 10	R	19	x 35	x 10	R	20	x 35	x 10	BA
17	x 35	x 10	R-DUO*	19	x 37	x 10	R*	20	x 35	x 10	R
17	x 35	x 10	RP	19	x 38	x 7	RP	20	x 35	x 10	RP
17	x 37	x 7	R	19	x 40	x 7	R	20	x 35	x 12	R*
17	x 37	x 10	B1*	19	x 40	x 10	R	20	x 36	x 7	R
17	x 37	x 10	R	19	x 47	x 10	RP	20	x 36	x 7	RP
17	x 38	x 7	R	19.05	x 28.58	x 6.35	RP	20	x 37	x 7	R
17	x 38	x 11	R*	19.05	x 31.75	x 4.76	R*	20	x 37	x 7	RP
17	x 40	x 7	R	19.05	x 31.75	x 6.35	R	20	x 37	x 8	R
17	x 40	x 7	RP	19.05	x 31.75	x 7.93	R	20	x 37	x 10	B2
17	x 40	x 8	RP	19.05	x 34.93	x 6.35	B1*	20	x 38	x 7	R
17	x 40	x 8.5	R*	19.05	x 34.93	x 6.35	R	20	x 38	x 7	RP
17	x 40	x 10	B2	19.05	x 34.93	x 9.52	B1*	20	x 38	x 8	BA
17	x 40	x 10	BA	19.05	x 38.1	x 7.93	B1*	20	x 38	x 8	R
17	x 40	x 10	R	19.05	x 38.1	x 7.93	R*	20	x 38	x 8	RP
17	x 47	x 7	R	19.05	x 38.1	x 7.93	RP	20	x 40	x 6	BA
17	x 47	x 7	RP	19.05	x 38.1	x 9.52	B1*	20	x 40	x 6	R
17	x 47	x 10	R	19.05	x 38.1	x 9.52	R	20	x 40	x 6	RP
17.46	x 34.93	x 9.52	B1*	19.05	x 41.28	x 7.93	R*	20	x 40	x 7	B1*
18	x 24	x 3	Rzv	19.8	x 32	x 5	R*	20	x 40	x 7	BA
18	x 24	x 4	B1of*	20	x 26	x 4	Rzv	20	x 40	x 7	R
18	x 24	x 4	Rzv	20	x 26	x 6	Rzv*	20	x 40	x 7	RP
18	x 25	x 7	R*	20	x 28	x 4	Rzv	20	x 40	x 8	BA
18	x 26	x 4	Rzv	20	x 28	x 6	BA	20	x 40	x 8	R
18	x 27	x 5	R*	20	x 28	x 6	B1	20	x 40	x 8	RP
18	x 28	x 4	R*	20	x 28	x 6	B1of	20	x 40	x 8.5	R*
18	x 28	x 7	R	20	x 28	x 6	R	20	x 40	x 10	B1SL
18	x 28	x 7	RP	20	x 28	x 7	R	20	x 40	x 10	B2
18	x 30	x 7	BA	20	x 30	x 4.5	R	20	x 40	x 10	BA
18	x 30	x 7	R	20	x 30	x 5	B1	20	x 40	x 10	R
18	x 30	x 7	RP	20	x 30	x 5	R	20	x 40	x 10	RP
18	x 30.2	x 5	B1*	20	x 30	x 6	R	20	x 42	x 7	R
18	x 32	x 6	R	20	x 30	x 6	RP	20	x 42	x 7	RP
18	x 32	x 7	R	20	x 30	x 7	B1	20	x 42	x 8	RP
18	x 32	x 7	RP	20	x 30	x 7	BA	20	x 42	x 10	B2
18	x 32	x 8	BA	20	x 30	x 7	R	20	x 42	x 10	R
18	x 32	x 8	R	20	x 30	x 7	RP	20	x 42	x 10	RP*
18	x 32	x 10	B2*	20	x 31	x 7	R	20	x 45	x 7	RP

## Oliekeerringen NBR DIN 3760

d	D	h	type	d	D	h	type	d	D	h	type
20	x 45	x 10	R	22	x 42	x 10	R	25	x 33	x 6	R
20	x 46	x 8	RP	22	x 45	x 7	R*	25	x 35	x 4	Rzv
20	x 47	x 7	BA	22	x 45	x 8	B1*	25	x 35	x 5	R
20	x 47	x 7	R	22	x 47	x 7	R	25	x 35	x 5	RP
20	x 47	x 7	RP	22	x 47	x 10	B2	25	x 35	x 7	B1
20	x 47	x 8	R	22	x 47	x 10	R	25	x 35	x 7	BA
20	x 47	x 8	RP	22	x 47	x 10	RP*	25	x 35	x 7	BASL
20	x 47	x 8.5	R*	22	x 48	x 10	R*	25	x 35	x 7	R
20	x 47	x 10	B2	22	x 56	x 8	R*	25	x 35	x 7	RP
20	x 47	x 10	BA	22.22	x 31.75	x 6.35	R	25	x 35	x 8	BA
20	x 47	x 10	R	22.22	x 34.93	x 6.35	B1*	25	x 35	x 8	R
20	x 47	x 10	RP	22.22	x 34.93	x 6.35	R*	25	x 35	x 8	RP
20	x 52	x 7	R	22.22	x 34.93	x 9.52	R	25	x 35	x 10	R
20	x 52	x 7	RP	22.22	x 38.1	x 6.35	B1*	25	x 36	x 7	R
20	x 52	x 8	R	22.22	x 38.1	x 6.35	R*	25	x 36	x 8	RP
20	x 52	x 10	B2	22.22	x 38.1	x 9.52	R*	25	x 37	x 5	R
20	x 52	x 10	BA	22.22	x 41.28	x 6.35	B1*	25	x 37	x 6	R
20	x 52	x 10	R	22.22	x 41.28	x 9.52	R	25	x 37	x 7	B1
20	x 52	x 10	RP	22.22	x 57.15	x 9.52	B1*	25	x 37	x 7	R
20	x 62	x 6.5	R*	23	x 32	x 7	RP	25	x 37	x 7	RP
21	x 29	x 4	Rzv	23	x 35	x 6	RP	25	x 37	x 8	RP
21	x 30	x 6.5	R	23	x 35	x 7	R	25	x 38	x 7	B1
21	x 35	x 7	RP*	23	x 38	x 8	R*	25	x 38	x 7	BA
21	x 40	x 7	RP	23	x 40	x 6	RP	25	x 38	x 7	R
21	x 47	x 10	R*	23	x 40	x 8	R	25	x 38	x 7	RP
21	x 48	x 8	R*	23	x 40	x 10	R	25	x 38	x 8	RP
22	x 28	x 4	Rzv	23	x 42	x 10	R	25	x 40	x 5	BA*
22	x 29	x 4	Rzv	23	x 47	x 10	RP	25	x 40	x 5	R
22	x 30	x 4	Rzv	23.81	x 38.1	x 9.52	B1*	25	x 40	x 6	R
22	x 32	x 5	R	24	x 32	x 4	Rzv	25	x 40	x 6	RP
22	x 32	x 5.5	R*	24	x 33	x 5	RP*	25	x 40	x 7	BA
22	x 32	x 6	B1	24	x 34	x 5.5	R	25	x 40	x 7	R
22	x 32	x 7	R	24	x 35	x 6	R	25	x 40	x 7	RP
22	x 32	x 7	RP	24	x 35	x 7	BA	25	x 40	x 8	B1
22	x 33	x 7	R*	24	x 35	x 7	R	25	x 40	x 8	BA
22	x 35	x 5	RP	24	x 35	x 8	RP*	25	x 40	x 8	R
22	x 35	x 5.5	R*	24	x 36	x 6	R	25	x 40	x 8	RP
22	x 35	x 6	R	24	x 36	x 7	RP*	25	x 40	x 10	B2
22	x 35	x 6.5	R*	24	x 37	x 7	BA	25	x 40	x 10	BA
22	x 35	x 7	BA	24	x 37	x 7	R	25	x 40	x 10	R
22	x 35	x 7	R	24	x 38	x 8	RP	25	x 40	x 10	RP
22	x 35	x 7	RP	24	x 40	x 7	R	25	x 42	x 6	R
22	x 35	x 8	RP	24	x 40	x 7	RP	25	x 42	x 7	BA
22	x 35	x 10	R	24	x 40	x 8.5	RP*	25	x 42	x 7	R
22	x 36	x 7	R	24	x 40	x 10	R	25	x 42	x 7	RP
22	x 36	x 8	RP*	24	x 42	x 8	R	25	x 42	x 8	B1*
22	x 37	x 7	R	24	x 47	x 7	R	25	x 42	x 8	RP
22	x 38	x 7	R	24	x 47	x 7	RP	25	x 42	x 8.5	R
22	x 38	x 8	BA	24	x 47	x 10	BA	25	x 42	x 10	B2
22	x 38	x 8	RP	24	x 47	x 10	R	25	x 42	x 10	BA
22	x 40	x 7	R	24	x 52	x 7	RP	25	x 42	x 10	R
22	x 40	x 7	RP	24	x 52	x 10	R	25	x 42	x 10	RP
22	x 40	x 8	BA	25	x 32	x 4	Rzv	25	x 42.9	x 9.5	BA
22	x 40	x 8	R	25	x 32	x 5	B1of	25	x 43	x 9	R
22	x 40	x 10	B2	25	x 32	x 6	R	25	x 45	x 7	R
22	x 40	x 10	BA	25	x 32	x 6	RP	25	x 45	x 10	B2
22	x 40	x 10	R	25	x 32	x 7	B1SL*	25	x 45	x 10	BA
22	x 42	x 7	R	25	x 33	x 4	R	25	x 45	x 10	R
22	x 42	x 7	RP*	25	x 33	x 4	Rzv	25	x 45	x 10	RP
22	x 42	x 10	B2	25	x 33	x 6	BA	25	x 46	x 7	R

## Oliekeerringen NBR DIN 3760

d	D	h	type	d	D	h	type	d	D	h	type
25	x 47	x 7	B1SL	26.99	x 41.28	x 7.93	B1*	28	x 52	x 10	RP
25	x 47	x 7	BA	27	x 35	x 4	R	28	x 55	x 9	R
25	x 47	x 7	R	27	x 35	x 7	R*	28	x 62	x 12	R*
25	x 47	x 7	RP	27	x 37	x 7	R	28.58	x 38.1	x 6.35	B1*
25	x 47	x 8	R	27	x 37	x 8.3	B1SL*	28.58	x 38.1	x 6.35	R
25	x 47	x 8	RP	27	x 40	x 7	R	28.58	x 39.69	x 7.93	R
25	x 47	x 10	B2	27	x 40	x 10	R*	28.58	x 41.28	x 6.35	B1*
25	x 47	x 10	BA	27	x 41	x 10	B2*	28.58	x 41.28	x 6.35	R
25	x 47	x 10	R	27	x 41	x 10	R*	28.58	x 41.28	x 7.93	B1*
25	x 47	x 10	RP	27	x 42	x 7	R*	28.58	x 41.28	x 7.93	R
25	x 48	x 8	R	27	x 42	x 10	RP	28.58	x 41.28	x 9.52	RP
25	x 50	x 10	B2	27	x 45	x 8	R*	28.58	x 44.45	x 9.52	B1*
25	x 50	x 10	R	27	x 47	x 6	R	28.58	x 44.45	x 11.1	B1*
25	x 50	x 10	RP	27	x 47	x 8	R	28.58	x 47.63	x 6.35	B1*
25	x 52	x 7	B1	27	x 47	x 8	RP*	28.58	x 47.63	x 6.35	R
25	x 52	x 7	R	27	x 47	x 10	R	28.58	x 47.63	x 9.52	B1*
25	x 52	x 7	RP	27	x 50	x 10	R	28.58	x 47.63	x 15.88	B2SL*
25	x 52	x 8	R	27	x 52	x 8	R	28.58	x 50.8	x 12.7	R
25	x 52	x 8	RP	28	x 35	x 4	Rzv	28.58	x 52.38	x 11.1	R*
25	x 52	x 10	B2	28	x 35	x 5	RP*	29	x 38	x 4	Rzv
25	x 52	x 10	R	28	x 37	x 4	Rzv	29	x 40	x 7	R
25	x 52	x 10	RP	28	x 37	x 6	RP*	29	x 41	x 5	R*
25	x 52	x 12	R*	28	x 38	x 6	R	29	x 42	x 7	R*
25	x 54	x 7	R*	28	x 38	x 7	B1*	29	x 45	x 10	R*
25	x 55	x 10	RP	28	x 38	x 7	R	29	x 47	x 10	R
25	x 58	x 10	R	28	x 38	x 7	RP	29	x 48	x 10	R*
25	x 62	x 7	B1*	28	x 40	x 5	R	29	x 50	x 10	R*
25	x 62	x 7	R	28	x 40	x 7	B1*	29	x 52	x 10	R*
25	x 62	x 7	RP	28	x 40	x 7	BA	29	x 62	x 10	R
25	x 62	x 8	R	28	x 40	x 7	R	30	x 37	x 4	Rzv
25	x 62	x 8	RP	28	x 40	x 7	RP	30	x 40	x 4	Rzv
25	x 62	x 10	R	28	x 40	x 8	RP	30	x 40	x 5	R
25	x 62	x 10	RP	28	x 40	x 10	B1*	30	x 40	x 7	B1*
25.4	x 36.51	x 6.35	RP	28	x 40	x 10	R	30	x 40	x 7	BA
25.4	x 38.1	x 6.35	B1*	28	x 42	x 6	R*	30	x 40	x 7	R
25.4	x 38.1	x 6.35	R	28	x 42	x 7	R	30	x 40	x 7	RP
25.4	x 38.1	x 9.52	B1*	28	x 42	x 7	RP	30	x 40	x 8	BA
25.4	x 38.1	x 9.52	R	28	x 42	x 8	BA	30	x 40	x 8	R
25.4	x 41.28	x 9.52	R	28	x 42	x 8	RP	30	x 40	x 8	RP
25.4	x 43.55	x 11.2	B2*	28	x 42	x 10	R	30	x 40	x 10	R
25.4	x 44.45	x 6.35	B1*	28	x 42.5	x 8	R*	30	x 42	x 5.7	R*
25.4	x 44.45	x 9.52	R	28	x 43	x 10	B1*	30	x 42	x 7	B1*
25.4	x 50.8	x 6.35	R	28	x 43	x 10	R*	30	x 42	x 7	BA
25.4	x 50.8	x 9.52	B1*	28	x 45	x 8	B1*	30	x 42	x 7	R
25.4	x 50.8	x 9.52	R	28	x 45	x 8	R	30	x 42	x 7	RP
25.4	x 50.8	x 12.7	R	28	x 45	x 10	B1*	30	x 42	x 8	R
26	x 34	x 4	Rzv	28	x 45	x 10	RP	30	x 42	x 8	RP
26	x 35	x 7	R	28	x 47	x 7	R	30	x 43	x 8	B1*
26	x 37	x 7	R	28	x 47	x 7	RP	30	x 44	x 10	R
26	x 38	x 5	RP	28	x 47	x 10	B2	30	x 45	x 5	R
26	x 38	x 7	RP	28	x 47	x 10	BA	30	x 45	x 7	BA
26	x 40	x 6	R	28	x 47	x 10	R	30	x 45	x 7	R
26	x 42	x 6	R*	28	x 47	x 10	RP	30	x 45	x 7	RP
26	x 42	x 7	R	28	x 48	x 10	R	30	x 45	x 8	BA
26	x 47	x 7	R	28	x 50	x 10	B2	30	x 45	x 8	R
26	x 47	x 10	R*	28	x 47	x 10	BA	30	x 45	x 7	RP
26	x 50	x 10	R	28	x 47	x 10	R	30	x 45	x 7	RP
26	x 52	x 8	B1*	28	x 47	x 10	RP	30	x 45	x 7	RP
26	x 52	x 8	R	28	x 48	x 10	R	30	x 45	x 8	BA
26	x 52	x 10	RP*	28	x 50	x 10	B2	30	x 45	x 8	R
				28	x 50	x 10	R	30	x 45	x 8	RP
				28	x 52	x 7	R	30	x 45	x 9.5	BA
				28	x 52	x 7	RP	30	x 45	x 10	BA
				28	x 52	x 10	BA	30	x 45	x 10	R
				28	x 52	x 10	R	30	x 46	x 5	RP*

## Oliekeerringen NBR DIN 3760

d	D	h	type	d	D	h	type	d	D	h	type
30	x 46	x 7	RP	30	x 60	x 10	R	32	x 47	x 10	R
30	x 47	x 5	R	30	x 62	x 7	R	32	x 47	x 10	RP*
30	x 47	x 6	R	30	x 62	x 7	RP	32	x 48	x 5	R
30	x 47	x 6	RP	30	x 62	x 8	RP	32	x 48	x 7	RP*
30	x 47	x 7	BA	30	x 62	x 10	B2*	32	x 48	x 8	R
30	x 47	x 7	R	30	x 62	x 10	BA*	32	x 48	x 8	RP
30	x 47	x 7	RP	30	x 62	x 10	R	32	x 50	x 6	RP
30	x 47	x 8	B1*	30	x 62	x 10	RP	32	x 50	x 7	B1
30	x 47	x 8	R	30	x 62	x 12	B2	32	x 50	x 8	R
30	x 47	x 8	RP	30	x 62	x 12	R	32	x 50	x 10	B2
30	x 47	x 10	B2	30	x 65	x 10	RP	32	x 50	x 10	BA
30	x 47	x 10	BA	30	x 68	x 10	R	32	x 50	x 10	R
30	x 47	x 10	R	30	x 72	x 10	B2	32	x 50	x 10	RP
30	x 47	x 10	RP	30	x 72	x 10	R	32	x 50	x 12	B2
30	x 48	x 8	BA	30	x 72	x 10	RP	32	x 50	x 12	R*
30	x 48	x 8	R	30.16	x 44.45	x 11.1	B1*	32	x 52	x 5	R*
30	x 48	x 8	RP	31	x 47	x 7	R	32	x 52	x 7	BA
30	x 48	x 10	B2	31	x 47	x 10	R*	32	x 52	x 7	R
30	x 48	x 10	R	31	x 52	x 6	R*	32	x 52	x 7	RP
30	x 50	x 5	R	31	x 52	x 7	R	32	x 52	x 8	RP
30	x 50	x 7	B1*	31	x 55	x 9	R*	32	x 52	x 10	B2
30	x 50	x 7	R	31.75	x 42.86	x 9.52	B1*	32	x 52	x 10	R
30	x 50	x 7	RP	31.75	x 44.45	x 6.35	B1*	32	x 52	x 10	RP
30	x 50	x 8	R	31.75	x 44.45	x 6.35	R	32	x 52	x 12	R
30	x 50	x 8	RP	31.75	x 44.45	x 9.52	B1*	32	x 54	x 10	RP
30	x 50	x 10	B2	31.75	x 47.63	x 7.93	B1*	32	x 55	x 10	BA
30	x 50	x 10	BA	31.75	x 47.63	x 7.93	RP	32	x 55	x 10	R
30	x 50	x 10	R	31.75	x 47.63	x 9.52	B1*	32	x 56	x 10	B1*
30	x 50	x 10	RP	31.75	x 47.63	x 9.52	R*	32	x 56	x 10	R
30	x 50	x 12	R*	31.75	x 47.63	x 11.1	R	32	x 56	x 10	RP
30	x 52	x 5	R	31.75	x 48.02	x 9.52	B1*	32	x 58	x 12	R
30	x 52	x 6	R	31.75	x 48.02	x 12	B2*	32	x 62	x 6	R
30	x 52	x 7	B1*	31.75	x 50.8	x 9.52	B1*	32	x 62	x 10	B2
30	x 52	x 7	BA	31.75	x 50.8	x 9.52	R	32	x 62	x 10	RP
30	x 52	x 7	R	31.75	x 50.8	x 11.1	R*	32	x 62	x 12	B2*
30	x 52	x 7	RP	31.75	x 50.8	x 12.7	R	32	x 66	x 10	R*
30	x 52	x 7	Sil.*	31.75	x 53.98	x 7.93	R	33	x 43	x 7	R*
30	x 52	x 8	R	31.75	x 57.15	x 7.93	B1*	33	x 50	x 6	RP*
30	x 52	x 8	RP	31.75	x 57.15	x 9.52	B1*	33	x 50	x 10	B2
30	x 52	x 10	B1*	31.75	x 57.15	x 9.52	RP*	33	x 50	x 10	R*
30	x 52	x 10	B2*	31.75	x 57.15	x 12.7	B1*	33	x 50	x 10	RP
30	x 52	x 10	BA	31.75	x 57.15	x 12.7	R	33	x 50	x 12	B1SL*
30	x 52	x 10	R	32	x 40	x 7	R	33	x 50	x 12	R*
30	x 52	x 10	R-DUO	32	x 42	x 4	Rzv	33	x 52	x 6	R
30	x 52	x 10	RP	32	x 42	x 5	RP	33	x 52	x 10	B2
30	x 52	x 12	B2	32	x 42	x 7	R	33	x 52	x 10	R
30	x 52	x 12	BA	32	x 42	x 7	RP	33.3	x 52.38	x 12.7	B1*
30	x 52	x 12	R	32	x 44	x 7	RP*	34	x 46	x 10	R
30	x 52	x 12	RP	32	x 45	x 4	Rzv	34	x 48	x 7	RP
30	x 55	x 6	R	32	x 45	x 6	BA	34	x 48	x 8	RP
30	x 55	x 7	R	32	x 45	x 6	R	34	x 50	x 10	R
30	x 55	x 7	RP	32	x 45	x 7	B1	34	x 52	x 7.5	R
30	x 55	x 10	BA	32	x 45	x 7	BA	34	x 52	x 8	R
30	x 55	x 10	R	32	x 45	x 7	R	34	x 52	x 10	B2
30	x 55	x 10	RP	32	x 45	x 7	RP	34	x 52	x 10	R
30	x 55	x 12	R*	32	x 45	x 8	R	34	x 62	x 10	BA*
30	x 55	x 12	RP	32	x 46	x 8	RP	34	x 62	x 10	R
30	x 56	x 10	BA	32	x 47	x 7	R	34	x 72	x 14.5	RP
30	x 56	x 10	R	32	x 47	x 7	RP	34.53	x 50.8	x 11.1	BASL*
30	x 56	x 10	RP*	32	x 47	x 8	RP	34.93	x 47.63	x 7.93	B1*

## Oliekeerringen NBR DIN 3760

d	D	h	type	d	D	h	type	d	D	h	type
34.93	x 47.63	x 7.93	R	35	x 55	x 8	BA	36	x 62	x 7	R
34.93	x 47.63	x 11.1	B1*	35	x 55	x 8	R	36	x 68	x 10	RP*
34.93	x 50.8	x 7.93	B1*	35	x 55	x 8	RP	36	x 75	x 12	R*
34.93	x 50.8	x 7.93	R	35	x 55	x 10	BA	36	x 83	x 12	R*
34.93	x 50.8	x 9.52	R	35	x 55	x 10	R	36.51	x 63.5	x 12.7	B1*
34.93	x 50.8	x 12.7	B1*	35	x 55	x 10	RP	37	x 47	x 4	Rzv
34.93	x 52.38	x 7.93	RP	35	x 55	x 12	B2	37	x 50	x 10	R
34.93	x 52.38	x 9.52	B1*	35	x 55	x 12/16	B1*	37	x 52	x 7	R
34.93	x 53.98	x 7.93	B1*	35	x 56	x 8	RP	37	x 52	x 8	R
34.93	x 53.98	x 9.52	B1*	35	x 56	x 10	B2	37	x 52	x 10	B2
34.93	x 53.98	x 11.1	B1*	35	x 56	x 10	BA	37	x 52	x 10	R*
34.93	x 57.15	x 9.52	R	35	x 56	x 10	R	37	x 62	x 8	R
34.93	x 57.15	x 12.7	B1*	35	x 56	x 10	RP	37	x 62	x 9	B2
34.93	x 60.3	x 12.7	B1*	35	x 56	x 12	BA	37	x 62	x 10	R
34.93	x 60.3	x 12.7	R*	35	x 56	x 12	R	38	x 48	x 4	Rzv
34.93	x 63.5	x 7.93	B1*	35	x 58	x 7.5	R	38	x 50	x 7	B1
34.93	x 63.5	x 12.7	B1*	35	x 58	x 10	R	38	x 50	x 7	BA
35	x 42	x 4	Rzv	35	x 58	x 10	Sil.*	38	x 50	x 7	R
35	x 43	x 4	Rzv	35	x 60	x 10	B2	38	x 50	x 7	RP
35	x 45	x 4	Rzv	35	x 60	x 10	R	38	x 50	x 8	RP
35	x 45	x 7	B1	35	x 60	x 12	R	38	x 52	x 7	R
35	x 45	x 7	R	35	x 62	x 5	B1	38	x 52	x 7	RP
35	x 45	x 7	RP	35	x 62	x 5	R	38	x 52	x 8	R
35	x 45	x 10	R	35	x 62	x 7	B1	38	x 52	x 8	RP
35	x 47	x 5	R	35	x 62	x 7	R	38	x 52	x 10	B1
35	x 47	x 6	R	35	x 62	x 7	RP	38	x 52	x 10	R
35	x 47	x 7	B1	35	x 62	x 8	R	38	x 52	x 10	RP
35	x 47	x 7	BA	35	x 62	x 8	RP	38	x 54	x 10	B1*
35	x 47	x 7	R	35	x 62	x 10	B2	38	x 54	x 10	R
35	x 47	x 7	RP	35	x 62	x 10	BA	38	x 55	x 6	R*
35	x 47	x 8	R	35	x 62	x 10	R	38	x 55	x 7	R
35	x 47	x 10	B1	35	x 62	x 10	RP	38	x 55	x 8	RP
35	x 47	x 10	R	35	x 62	x 12	B2	38	x 55	x 10	R
35	x 48	x 8	RP	35	x 62	x 12	R*	38	x 55	x 12	B2
35	x 50	x 7	BA	35	x 62	x 12	RP	38	x 55.5	x 9	R*
35	x 50	x 7	R	35	x 65	x 10	B2	38	x 56	x 10	R
35	x 50	x 7	RP	35	x 65	x 10	R	38	x 58	x 10	R
35	x 50	x 8	R	35	x 65	x 10	RP	38	x 60	x 10	R
35	x 50	x 8	RP	35	x 65	x 12	R	38	x 60	x 10	RP*
35	x 50	x 10	B2	35	x 68	x 6	R	38	x 62	x 7	R
35	x 50	x 10	BA	35	x 68	x 10	RP*	38	x 62	x 7	RP
35	x 50	x 10	R	35	x 70	x 10	R	38	x 62	x 10	B2
35	x 50	x 10	RP	35	x 72	x 7	R	38	x 62	x 10	BA
35	x 50	x 12	B2	35	x 72	x 10	R	38	x 62	x 10	R
35	x 52	x 7	BA	35	x 72	x 10	RP	38	x 62	x 10	RP
35	x 52	x 7	R	35	x 72	x 12	B2	38	x 62	x 12	B2
35	x 52	x 7	RP	35	x 72	x 12	R	38	x 65	x 10	R
35	x 52	x 8	R	35	x 72	x 12	RP	38	x 65	x 12	B2*
35	x 52	x 8	RP	35	x 80	x 10	R	38	x 72	x 10	R
35	x 52	x 8.8	R	35	x 80	x 10	RP	38	x 72	x 12	B2
35	x 52	x 9	RP*	35	x 80	x 12	R	38.1	x 50.8	x 6.35	B1*
35	x 52	x 10	B2	36	x 47	x 7	R	38.1	x 52.39	x 7.93	B1*
35	x 52	x 10	BA	36	x 48	x 10	R	38.1	x 55.56	x 9.52	B1*
35	x 52	x 10	R	36	x 50	x 7	R	38.1	x 57.15	x 7.93	B1*
35	x 52	x 10	RP	36	x 50	x 10	R*	38.1	x 57.15	x 9.52	B1*
35	x 52	x 12	B2	36	x 52	x 7	R	38.1	x 57.15	x 9.52	R*
35	x 52	x 12	R*	36	x 52	x 7	RP*	38.1	x 57.15	x 12.7	R*
35	x 54	x 8	RP*	36	x 54	x 7	R	38.1	x 60.3	x 12.7	B1*
35	x 54	x 10	R	36	x 56	x 10	R	38.1	x 61.91	x 12/14	B1*
35	x 55	x 7	R	36	x 59	x 9.5	R*	38.1	x 63.5	x 9.52	R

## Oliekeerringen NBR DIN 3760

d	D	h	type	d	D	h	type	d	D	h	type
38.1	x 63.5	x 12.7	B1*	40	x 60	x 12	B2	42	x 52	x 8	RP*
38.1	x 63.5	x 12.7	R	40	x 62	x 7	B1	42	x 55	x 7	BA
38.1	x 69.85	x 12.7	B1*	40	x 62	x 7	R	42	x 55	x 7	R
39	x 52	x 9	RP*	40	x 62	x 7	RP	42	x 55	x 7	RP
39.69	x 60.3	x 9.52	B1*	40	x 62	x 8	RP	42	x 55	x 8	R
39.69	x 60.3	x 9.52	R	40	x 62	x 10	B2	42	x 55	x 8	RP
39.69	x 68.18	x 11.1	B2SL*	40	x 62	x 10	BA	42	x 55	x 9	RP
39.69	x 68.33	x 11.1	R*	40	x 62	x 10	R	42	x 56	x 6	R*
40	x 47	x 4	Rzv	40	x 62	x 10	RP	42	x 56	x 7	B1
40	x 48	x 4	Rzv	40	x 62	x 12	B2	42	x 56	x 7	BA
40	x 50	x 4	Rzv	40	x 62	x 12	R	42	x 56	x 7	R
40	x 50	x 6.5	RP	40	x 62	x 12	RP	42	x 56	x 7	RP
40	x 50	x 8	R	40	x 63	x 10	R	42	x 58	x 8	RP
40	x 52	x 5	RP	40	x 65	x 10	B2	42	x 58	x 10	B1*
40	x 52	x 5	Rzv*	40	x 65	x 10	BA	42	x 58	x 10	R
40	x 52	x 6	R	40	x 65	x 10	R	42	x 58	x 12	R*
40	x 52	x 7	B1	40	x 65	x 10	RP	42	x 60	x 7	RP
40	x 52	x 7	BA	40	x 65	x 12	B2	42	x 60	x 10	B2
40	x 52	x 7	R	40	x 65	x 12	R	42	x 60	x 10	R
40	x 52	x 7	RP	40	x 68	x 7	B1*	42	x 62	x 7	B1
40	x 52	x 8	R	40	x 68	x 8	R	42	x 62	x 7	R
40	x 52	x 8	RP	40	x 68	x 8	RP*	42	x 62	x 7	RP
40	x 52	x 10	R	40	x 68	x 10	BA	42	x 62	x 8	BASL*
40	x 55	x 7	R	40	x 68	x 10	R	42	x 62	x 8	R
40	x 55	x 7	RP	40	x 68	x 10	RP	42	x 62	x 8	RP
40	x 55	x 8	B1	40	x 68	x 12	B2	42	x 62	x 10	B2
40	x 55	x 8	R	40	x 70	x 10	BA	42	x 62	x 10	R
40	x 55	x 8	RP	40	x 70	x 10	R	42	x 62	x 10	RP
40	x 55	x 10	BA	40	x 70	x 12	B2	42	x 62	x 12	B2
40	x 55	x 10	R	40	x 72	x 7	BA	42	x 62	x 12	R
40	x 55	x 10	RP	40	x 72	x 7	RP	42	x 65	x 8	R
40	x 55	x 12	B2	40	x 72	x 7	R	42	x 65	x 10	B2
40	x 55.5	x 9	B1*	40	x 72	x 10	B2	42	x 65	x 10	R
40	x 56	x 7	RP	40	x 72	x 10	BA	42	x 65	x 10	RP
40	x 56	x 7	Sil.*	40	x 72	x 10	R	42	x 65	x 12	B2
40	x 56	x 8	R	40	x 72	x 10	RP	42	x 65	x 12	R
40	x 56	x 10	B2	40	x 72	x 12	B2	42	x 65	x 12	Sil.*
40	x 56	x 10	BA	40	x 72	x 12	RP	42	x 68	x 10	R
40	x 56	x 10	R	40	x 78	x 10	RP	42	x 68	x 11.5	R*
40	x 56	x 10	RP	40	x 80	x 8	RP	42	x 70	x 10	R
40	x 56	x 10	Sil.*	40	x 80	x 10	R	42	x 72	x 8	R
40	x 56	x 12	R	40	x 80	x 10	RP	42	x 72	x 10	R
40	x 57.15	x 10	B1*	40	x 80	x 12	RP	42	x 72	x 12	B2
40	x 58	x 8	RP	40	x 80	x 13	B2	42	x 80	x 10	R*
40	x 58	x 8	Sil.*	40	x 85	x 10	R	42	x 81	x 13	R*
40	x 58	x 9	B1	40	x 90	x 9	RP*	42.86	x 63.5	x 9.52	B1*
40	x 58	x 9	R	40	x 90	x 10	R	42.86	x 63.5	x 9.52	R
40	x 58	x 10	B1*	40	x 90	x 10	RP	43	x 53	x 4	Rzv
40	x 58	x 10	B2	41	x 62	x 10	R	43	x 60	x 10	R
40	x 58	x 10	R	41.28	x 55.56	x 9.52	B1*	43	x 62	x 10	R
40	x 58	x 10	RP	41.28	x 60.3	x 7.93	R	43	x 66	x 10	R*
40	x 58	x 12	B1*	41.28	x 60.3	x 9.52	B1*	43	x 66	x 12	R*
40	x 58	x 12	R	41.28	x 60.3	x 12.7	B1*	44	x 54	x 4.5	R*
40	x 59	x 9.5	RP*	41.28	x 63.5	x 7.93	B1*	44	x 60	x 10	R
40	x 60	x 7	R	41.28	x 63.5	x 7.93	RP	44	x 62	x 10	B2
40	x 60	x 8	RP*	41.28	x 63.5	x 12.7	B1*	44	x 62	x 10	RP
40	x 60	x 10	B2	41.28	x 66.68	x 9.52	R*	44	x 65	x 10	BA
40	x 60	x 10	BA	42	x 50	x 7	R	44	x 65	x 10	R
40	x 60	x 10	R	42	x 52	x 4	RP	44	x 65	x 12	R*
40	x 60	x 10	RP	42	x 52	x 4	Rzv	44	x 70	x 12	R*

## Oliekeerringen NBR DIN 3760

d	D	h	type	d	D	h	type	d	D	h	type
44	x 72	x 7	R*	45	x 65	x 12	B2	48	x 62	x 8	RP
44	x 72	x 10	R*	45	x 65	x 12	R	48	x 62	x 10	R
44	x 72	x 12	R*	45	x 66	x 10	R	48	x 62	x 10	RP
44	x 80	x 13	R*	45	x 68	x 10	B2	48	x 65	x 7	RP
44.45	x 57.15	x 9.52	RP*	45	x 68	x 10	R	48	x 65	x 10	B2
44.45	x 58.73	x 6.35	B1*	45	x 68	x 10	RP*	48	x 65	x 10	BA
44.45	x 60.3	x 7.93	B1*	45	x 68	x 12	B2	48	x 65	x 10	R
44.45	x 60.3	x 9.52	RP	45	x 68	x 12	R	48	x 65	x 10	RP
44.45	x 60.3	x 12.7	B1*	45	x 68	x 12	RP	48	x 65	x 12	B2
44.45	x 60.3	x 12.7	RP	45	x 70	x 10	B2	48	x 65	x 12	R*
44.45	x 61.91	x 6.35	R	45	x 70	x 10	R	48	x 65	x 12	R-DUO*
44.45	x 63.5	x 7.93	R	45	x 70	x 10	RP	48	x 68	x 10	B2
44.45	x 63.5	x 9.52	R	45	x 70	x 12	B2	48	x 68	x 10	RP*
44.45	x 63.5	x 12.7	B1*	45	x 70	x 12	R	48	x 68	x 12	R
44.45	x 63.5	x 12.7	R	45	x 72	x 7	R*	48	x 68	x 14	RP
44.45	x 69.85	x 9.52	R	45	x 72	x 8	R	48	x 69	x 10	R
44.45	x 69.85	x 12.7	B1*	45	x 72	x 8	RP	48	x 69	x 12	B2*
44.45	x 69.85	x 12.7	R	45	x 72	x 10	B2	48	x 70	x 10	B2
44.45	x 73.03	x 9.52	B1*	45	x 72	x 10	BA	48	x 70	x 10	BA
44.45	x 73.03	x 12.7	B1*	45	x 72	x 10	R	48	x 70	x 10	R
44.45	x 73.03	x 12.7	RP	45	x 72	x 10	RP	48	x 70	x 12	B2
44.45	x 80.96	x 12.7	B1*	45	x 72	x 12	B2	48	x 72	x 7	R
45	x 52	x 4	Rzv	45	x 72	x 12	R	48	x 72	x 7	RP
45	x 55	x 4	Rzv	45	x 72	x 12	RP	48	x 72	x 8	R
45	x 55	x 7	B1	45	x 75	x 8	R	48	x 72	x 10	B2
45	x 55	x 7	R	45	x 75	x 8	RP	48	x 72	x 10	BA
45	x 55	x 10	RP*	45	x 75	x 10	BA	48	x 72	x 10	R
45	x 58	x 7	BA	45	x 75	x 10	R	48	x 72	x 10	RP
45	x 58	x 7	R	45	x 75	x 10	RP	48	x 72	x 12	B2
45	x 58	x 7	RP	45	x 80	x 8	BA	48	x 72	x 12	BA
45	x 60	x 7	BA	45	x 80	x 10	B2	48	x 72	x 12	RP
45	x 60	x 7	R	45	x 80	x 10	R	48	x 74	x 10	R*
45	x 60	x 7	RP	45	x 80	x 10	RP	48	x 80	x 8	R
45	x 60	x 7	Sil.*	45	x 80	x 12	R	48	x 80	x 10	B2
45	x 60	x 8	R	45	x 80	x 13	B2	48	x 80	x 10	R
45	x 60	x 8	RP	45	x 80	x 13	R*	48	x 80	x 10	RP
45	x 60	x 10	B2	45	x 85	x 8	RP*	48	x 80	x 13	B2
45	x 60	x 10	BA	45	x 85	x 10	R	48	x 80	x 13	RP
45	x 60	x 10	R	45	x 85	x 10	RP	48	x 85	x 6	R*
45	x 60	x 10	RP	45	x 85	x 13	B2	48	x 85	x 10	R*
45	x 62	x 7	BA	45	x 90	x 10	R	48	x 85	x 13	R*
45	x 62	x 7	R	45	x 90	x 10	RP	49.2	x 63.5	x 9.52	B1*
45	x 62	x 7	RP	46	x 62	x 8	RP	49.2	x 76.2	x 12.7	B1*
45	x 62	x 8	R	46	x 64	x 8	R*	49.2	x 76.2	x 15.88	B2SL*
45	x 62	x 8	RP	46	x 65	x 10	R*	50	x 58	x 4	Rzv
45	x 62	x 10	B2	46	x 72	x 10	R*	50	x 60	x 8	R*
45	x 62	x 10	BA	47	x 62	x 7	RP	50	x 60	x 10	RP
45	x 62	x 10	R	47	x 65	x 10	R	50	x 62	x 5	Rzv*
45	x 62	x 10	RP	47.63	x 63.5	x 7.93	R	50	x 62	x 7	B1*
45	x 62	x 12	B2	47.63	x 63.5	x 12.7	B1*	50	x 62	x 7	R
45	x 62	x 12	R	47.63	x 66.68	x 9.52	B1*	50	x 62	x 7	RP
45	x 65	x 8	BA	47.63	x 66.68	x 9.52	R	50	x 62	x 10	R
45	x 65	x 8	R	47.63	x 68.26	x 12.7	B1*	50	x 65	x 8	B1
45	x 65	x 8	RP	47.63	x 69.85	x 9.52	B1*	50	x 65	x 8	BA
45	x 65	x 10	B1*	47.63	x 69.85	x 12.7	R	50	x 65	x 8	R
45	x 65	x 10	B2	47.63	x 73.03	x 9.52	R*	50	x 65	x 8	RP
45	x 65	x 10	BA	47.63	x 76.2	x 12.7	RP*	50	x 65	x 10	B2
45	x 65	x 10	R	48	x 62	x 7	RP	50	x 65	x 10	BA
45	x 65	x 10	RP	48	x 62	x 8	BA	50	x 65	x 10	R
45	x 65	x 10	Sil.*	48	x 62	x 8	R	50	x 65	x 10	RP



## Oliekeerringen NBR DIN 3760

d	D	h	type	d	D	h	type	d	D	h	type
50	x 68	x 8	R	52	x 62	x 7	R	55	x 72	x 12	B2
50	x 68	x 8	RP	52	x 62	x 8	R	55	x 72	x 12	R
50	x 68	x 10	B2	52	x 65	x 8	R	55	x 75	x 8	R*
50	x 68	x 10	BA	52	x 68	x 8	BA	55	x 75	x 10	BA
50	x 68	x 10	R	52	x 68	x 8	R	55	x 75	x 10	R
50	x 68	x 10	RP	52	x 68	x 8	RP	55	x 75	x 10	RP
50	x 68	x 12	B2	52	x 68	x 10	B2	55	x 75	x 12	B2
50	x 68	x 12	R*	52	x 68	x 10	R	55	x 75	x 12	R
50	x 70	x 8	R	52	x 69	x 10	Sil.*	55	x 78	x 10	R
50	x 70	x 10	B2	52	x 70	x 10	B2	55	x 78	x 10	RP*
50	x 70	x 10	BA	52	x 72	x 8	R	55	x 78	x 13	B2
50	x 70	x 10	R	52	x 72	x 10	B2	55	x 80	x 8	R
50	x 70	x 10	RP	52	x 72	x 10	BA	55	x 80	x 8	RP
50	x 70	x 12	B2	52	x 72	x 10	R	55	x 80	x 10	B2
50	x 70	x 12	R	52	x 72	x 10	RP	55	x 80	x 10	BA
50	x 72	x 8	R	52	x 72	x 12	B2	55	x 80	x 10	R
50	x 72	x 8	RP	52	x 72	x 12	RP	55	x 80	x 10	RP
50	x 72	x 10	B2	52	x 75	x 10	BA	55	x 80	x 12	B2
50	x 72	x 10	BA	52	x 75	x 12	R	55	x 80	x 13	BA
50	x 72	x 10	R	52	x 80	x 10	B2	55	x 80	x 13	R
50	x 72	x 10	RP	52	x 80	x 10	R	55	x 85	x 8	BA
50	x 72	x 12	B2	52	x 80	x 13	B2	55	x 85	x 8	R
50	x 72	x 12	R	52	x 80	x 13	R	55	x 85	x 10	B2
50	x 72	x 12	RP	52	x 85	x 10	B2	55	x 85	x 10	R
50	x 75	x 10	BA	52	x 85	x 10	R	55	x 85	x 10	RP
50	x 75	x 10	R	52	x 85	x 10	RP*	55	x 85	x 13	B2
50	x 75	x 12	B2	52	x 85	x 12	R*	55	x 85	x 13	R
50	x 75	x 12	R	53	x 68	x 10	R	55	x 90	x 8	R
50	x 75	x 12	RP	53.98	x 69.85	x 7.93	B1*	55	x 90	x 8	RP
50	x 78	x 10	BA	53.98	x 73.03	x 9.52	B1*	55	x 90	x 10	BA
50	x 78	x 13	RP	53.98	x 73.03	x 9.52	RP	55	x 90	x 10	R
50	x 80	x 8	R	53.98	x 76.2	x 12.7	B1*	55	x 90	x 10	RP
50	x 80	x 8	RP	54	x 72	x 10	B2	55	x 90	x 13	R
50	x 80	x 10	B2	54	x 72	x 10	R	55	x 100	x 10	RP
50	x 80	x 10	BA	54	x 80	x 10	B2	55	x 100	x 13	R
50	x 80	x 10	R	54	x 80	x 13	B2	55	x 100	x 13	RP*
50	x 80	x 10	RP	54	x 82	x 10	RP*	56	x 70	x 8	R*
50	x 80	x 12	RP	54	x 85	x 10	R*	56	x 72	x 8	R
50	x 80	x 13	B2	55	x 63	x 5	Rzv	56	x 80	x 8	R
50	x 80	x 13	BA	55	x 68	x 8	BA	56	x 85	x 8	R*
50	x 80	x 13	R	55	x 68	x 8	R	56	x 88	x 10	R*
50	x 85	x 10	R	55	x 68	x 8	RP	56	x 88	x 13	R*
50	x 85	x 10	RP	55	x 68	x 10	R	57	x 85	x 13	R*
50	x 85	x 13	R	55	x 70	x 8	B1	57	x 90	x 13	B2*
50	x 90	x 10	BA*	55	x 70	x 8	BA	57.15	x 73.03	x 9.52	B1*
50	x 90	x 10	R	55	x 70	x 8	R	57.15	x 76.2	x 9.52	R
50	x 90	x 10	RP	55	x 70	x 8	RP	57.15	x 82.55	x 12.7	B1*
50	x 90	x 13	B2	55	x 70	x 8	Sil.*	57.15	x 82.55	x 12.7	R*
50.8	x 69.85	x 6.35	R	55	x 70	x 10	BA	57.15	x 85.09	x 13	B2*
50.8	x 69.85	x 9.52	B1*	55	x 70	x 10	R	57.15	x 85.73	x 12.7	B1*
50.8	x 69.85	x 9.52	R	55	x 70	x 10	RP	58	x 72	x 8	BA
50.8	x 69.85	x 12.7	B1*	55	x 72	x 7	RP	58	x 72	x 8	R
50.8	x 69.85	x 12.7	R	55	x 72	x 8	BA	58	x 72	x 10	RP
50.8	x 73.03	x 9.52	R	55	x 72	x 8	R	58	x 75	x 10	BA
50.8	x 73.03	x 12.7	B1*	55	x 72	x 8	RP	58	x 75	x 10	RP
50.8	x 73.03	x 12.7	RP	55	x 72	x 10	B2	58	x 75	x 12	B2
50.8	x 76.2	x 9.52	B1*	55	x 72	x 10	BA	58	x 80	x 8	R
50.8	x 76.2	x 12.7	B1*	55	x 72	x 10	BASL	58	x 80	x 10	B2
50.8	x 76.2	x 12.7	R	55	x 72	x 10	R	58	x 80	x 10	R
52	x 60	x 5	Rvz	55	x 72	x 10	RP	58	x 80	x 10	RP

## Oliekeerringen NBR DIN 3760

d	D	h	type	d	D	h	type	d	D	h	type
58	x 80	x 12	B2	60	x 110	x 13	RP	65	x 85	x 12	RP
58	x 85	x 10	B2	60.3	x 85.73	x 12.7	B1*	65	x 85	x 13	B1SL
58	x 85	x 10	R	60.3	x 88.9	x 12.7	B1*	65	x 85	x 13	B2
58	x 85	x 13	R	60.3	x 90.09	x 12.7	B1*	65	x 85	x 13	RP
58	x 90	x 10	R	60.5	x 78	x 9	RP*	65	x 90	x 10	B2
60	x 70	x 7	R	61.91	x 82.75	x 9.52	R*	65	x 90	x 10	BA
60	x 72	x 8	B1	62	x 80	x 10	B2	65	x 90	x 10	R
60	x 72	x 8	R	62	x 80	x 10	BA	65	x 90	x 10	RP
60	x 72	x 10	R	62	x 80	x 10	R	65	x 90	x 12	R
60	x 72	x 10	RP	62	x 80	x 10	RP	65	x 90	x 12	RP
60	x 74	x 10	RP	62	x 80	x 12	B2	65	x 90	x 13	B1SL
60	x 75	x 8	B1	62	x 80	x 12	R	65	x 90	x 13	B2
60	x 75	x 8	BA	62	x 80	x 12	Sil.*	65	x 90	x 13	BA
60	x 75	x 8	R	62	x 85	x 10	B2	65	x 90	x 13	R
60	x 75	x 8	RP	62	x 85	x 10	R	65	x 90	x 13	RP
60	x 75	x 10	R	62	x 85	x 10	RP	65	x 95	x 10	R
60	x 75	x 10	RP*	62	x 85	x 13	B2	65	x 95	x 13	B2
60	x 75	x 12	R	62	x 85	x 13	R	65	x 100	x 10	B2
60	x 78	x 9	RP	62	x 90	x 10	B2	65	x 100	x 10	R
60	x 78	x 10	BA	62	x 90	x 10	R	65	x 100	x 10	RP
60	x 78	x 10	R	62	x 90	x 10	RP*	65	x 100	x 12	R
60	x 78	x 13	B2	62	x 90	x 12	B2	65	x 100	x 13	B2
60	x 80	x 8	BA	62	x 90	x 13	R*	65	x 100	x 13	R
60	x 80	x 8	R	62	x 100	x 12	R*	65	x 110	x 10	R
60	x 80	x 8	RP	63	x 85	x 10	B2	65	x 120	x 12	RP
60	x 80	x 10	B2	63	x 85	x 10	R	65	x 120	x 13	RP
60	x 80	x 10	BA	63	x 90	x 10	R	65.88	x 88.5	x 12.7	B2*
60	x 80	x 10	R	63	x 100	x 10	R*	66.68	x 85.73	x 7.93	B1*
60	x 80	x 10	RP	63	x 110	x 13	R*	66.68	x 85.73	x 9.52	B1*
60	x 80	x 12	B2	63.5	x 79.37	x 12.7	B1*	66.68	x 88.9	x 12.7	B1*
60	x 80	x 12	R	63.5	x 82.55	x 9.52	B1*	66.68	x 88.9	x 12.7	R
60	x 80	x 13	B1SL	63.5	x 82.55	x 9.52	R	66.68	x 95.25	x 12.7	B1*
60	x 80	x 13	B2	63.5	x 82.55	x 12.7	B1*	68	x 80	x 8	R
60	x 80	x 13	R	63.5	x 82.55	x 12.7	R	68	x 85	x 10	R
60	x 85	x 8	R	63.5	x 85.73	x 12.7	B1*	68	x 87	x 8	RP*
60	x 85	x 8	RP	63.5	x 88.9	x 9.52	B1*	68	x 90	x 10	B2
60	x 85	x 10	B2	63.5	x 88.9	x 9.52	R	68	x 90	x 10	BA
60	x 85	x 10	BA	63.5	x 88.9	x 12.7	B1*	68	x 90	x 10	R
60	x 85	x 10	R	63.5	x 90.09	x 12.7	B1*	68	x 90	x 10	RP
60	x 85	x 10	RP	63.5	x 95.25	x 12.7	B1*	68	x 90	x 12	B2
60	x 85	x 12	B2	64	x 80	x 8	BA	68	x 90	x 13	RP*
60	x 85	x 12	RP	64	x 80	x 8	RP	68	x 94	x 8	RP*
60	x 85	x 13	B2	64	x 80	x 8	Sil.*	68	x 95	x 13	R*
60	x 85	x 13	R	64	x 85	x 13	R*	68	x 100	x 10	R
60	x 90	x 8	BA	64	x 90	x 10	B2	68	x 100	x 12	B2
60	x 90	x 8	R	64	x 90	x 13	B2	69.85	x 88.9	x 9.52	B1*
60	x 90	x 8	RP	65	x 75	x 8	RP	69.85	x 88.9	x 9.52	RP
60	x 90	x 10	B2	65	x 80	x 8	BA	69.85	x 88.9	x 12.7	B1*
60	x 90	x 10	BA	65	x 80	x 8	R	69.85	x 88.9	x 12.7	RP
60	x 90	x 10	R	65	x 80	x 8	RP	69.85	x 95.25	x 12.7	B1*
60	x 90	x 10	RP	65	x 80	x 10	R	69.85	x 98.43	x 12.7	RP*
60	x 90	x 12	B2	65	x 80	x 10	RP	69.85	x 101.6	x 12.7	R*
60	x 90	x 13	B1SL	65	x 80	x 12	R	70	x 78	x 5	Rzv
60	x 90	x 13	R	65	x 82	x 10	R	70	x 85	x 7	R
60	x 95	x 10	BA	65	x 85	x 8	R	70	x 85	x 8	B1*
60	x 95	x 10	R	65	x 85	x 10	B2	70	x 85	x 8	R
60	x 95	x 13	B2	65	x 85	x 10	BA	70	x 85	x 8	RP
60	x 100	x 10	R	65	x 85	x 10	R	70	x 85	x 8	Sil.*
60	x 100	x 13	RP*	65	x 85	x 10	RP	70	x 85	x 10	R
60	x 110	x 13	R	65	x 85	x 12	R	70	x 90	x 7	RP

## Oliekeerringen NBR DIN 3760

d	D	h	type	d	D	h	type	d	D	h	type
70	x 90	x 8	R	75	x 90	x 10	BA	80	x 110	x 10	R
70	x 90	x 10	B2	75	x 90	x 10	R	80	x 110	x 10	RP
70	x 90	x 10	BA	75	x 90	x 10	RP*	80	x 110	x 12	R
70	x 90	x 10	BASL	75	x 95	x 8	RP*	80	x 110	x 12	RP
70	x 90	x 10	R	75	x 95	x 10	B2	80	x 110	x 13	B2
70	x 90	x 10	RP	75	x 95	x 10	BA	80	x 110	x 13	R
70	x 90	x 12	B2	75	x 95	x 10	R	80	x 115	x 10	BA
70	x 90	x 12	R	75	x 95	x 10	RP	80	x 115	x 12	R*
70	x 90	x 12	RP	75	x 95	x 12	B2	80	x 120	x 13	B2
70	x 90	x 13	B2	75	x 95	x 12	R	80	x 120	x 13	R
70	x 90	x 13	B2SL	75	x 95	x 13	R	80	x 125	x 12	R
70	x 90	x 13	BA	75	x 100	x 10	B2	80	x 125	x 13	B2
70	x 90	x 13	R	75	x 100	x 10	BA	80	x 145	x 13	R*
70	x 92	x 13	R	75	x 100	x 10	R	80.96	x 114.3	x 12.7	B2*
70	x 95	x 10	B2	75	x 100	x 10	RP	80.96	x 117.5	x 13	B2*
70	x 95	x 10	BA	75	x 100	x 12	B2	80.96	x 120.65x 12.7	RP	
70	x 95	x 10	R	75	x 100	x 13	B2	82	x 105	x 12	R
70	x 95	x 13	B2	75	x 100	x 13	B2SL	82	x 105	x 13	B2
70	x 95	x 13	R*	75	x 100	x 13	BA	82	x 110	x 12	R
70	x 95	x 13	RP	75	x 100	x 13	R	82	x 110	x 13	B2
70	x 100	x 8	RP*	75	x 100	x 13	RP	82.55	x 114.3	x 12.7	B1*
70	x 100	x 10	B2	75	x 105	x 13	B2	82.55	x 114.3	x 15.88	R*
70	x 100	x 10	BA	75	x 105	x 15	RP	85	x 100	x 9	B1
70	x 100	x 10	R	75	x 110	x 12	R	85	x 100	x 10	RP
70	x 100	x 10	RP	75	x 110	x 13	B2	85	x 100	x 13	B2
70	x 100	x 12	R	75	x 120	x 12	R*	85	x 100	x 13	R
70	x 100	x 13	B2	75.41	x 101.6	x 19.05	B2SL*	85	x 101	x 9	B1*
70	x 100	x 13	BA	76.2	x 95.25	x 9.52	RP	85	x 105	x 10	B1
70	x 100	x 13	R	76.2	x 101.6	x 11.1	B1*	85	x 105	x 10	RP
70	x 105	x 13	R	76.2	x 101.6	x 12.7	B1*	85	x 105	x 13	B2
70	x 110	x 8	R	76.2	x 101.6	x 12.7	R	85	x 105	x 13	BA
70	x 110	x 10	R	77	x 100	x 10	R	85	x 105	x 13	R
70	x 110	x 10	RP	77.78	x 104.75x 12.7	R*		85	x 110	x 10	R
70	x 110	x 12	R	78	x 95	x 13	B2	85	x 110	x 10	RP*
70	x 110	x 13	B2	78	x 100	x 10	B2	85	x 110	x 12	BA
70	x 110	x 13	BA	78	x 100	x 10	R	85	x 110	x 12	R
70	x 110	x 13	RP	78	x 100	x 10	RP*	85	x 110	x 12	RP
70	x 111	x 13	R*	78	x 100	x 12	B2	85	x 110	x 13	B2
70	x 112	x 12	R*	78	x 110	x 12	R*	85	x 110	x 13	B2SL
72	x 85	x 8	R	78	x 110	x 13	B2	85	x 110	x 13	BA
72	x 90	x 10	B2	79.3	x 101.6	x 12.7	B1*	85	x 110	x 13	RP
72	x 90	x 10	BA	80	x 95	x 8	R	85	x 115	x 13	B2
72	x 90	x 10	R	80	x 95	x 10	R	85	x 115	x 13	R
72	x 95	x 10	B2	80	x 100	x 10	B2	85	x 120	x 12	R
72	x 95	x 10	R	80	x 100	x 10	BA	85	x 120	x 12	RP
72	x 95	x 10	RP*	80	x 100	x 10	R	85	x 120	x 13	B2
72	x 95	x 13	B2	80	x 100	x 10	RP	85	x 120	x 13	R
72	x 100	x 10	B2	80	x 100	x 12	RP	85	x 125	x 12	R
72	x 100	x 10	R	80	x 100	x 13	B1SL	85	x 130	x 12	R
72	x 110	x 12	R	80	x 100	x 13	B2	85	x 130	x 12	RP
72	x 110	x 13	RP	80	x 100	x 13	B2SL	85	x 130	x 13	B2
73.03	x 85.73	x 4.76	R*	80	x 100	x 13	BA	85	x 130	x 13	RP*
73.03	x 92.08	x 9.52	R	80	x 100	x 13	R	85	x 140	x 12	R
73.03	x 95.25	x 12.7	B1*	80	x 100	x 13	RP	85	x 155	x 12	R*
74	x 90	x 10	B2	80	x 105	x 10	R	85.5	x 119.1	x 12.7	BA*
74	x 100	x 13	B2	80	x 105	x 12	RP*	85.73	x 111.12x 12.7	R	
74	x 105	x 12	R*	80	x 105	x 13	B2	87.31	x 114.3	x 12.7	B1*
75	x 90	x 8	BA	80	x 105	x 13	BA	88	x 105	x 12	R*
75	x 90	x 8	R	80	x 105	x 13	R	88	x 110	x 12	R
75	x 90	x 8	RP	80	x 105	x 13	RP	88	x 110	x 13	B2

## Oliekeerringen NBR DIN 3760

d	D	h	type	d	D	h	type	d	D	h	type
88	x 120	x 13	R	95.25	x 127	x 11	B2*	110	x 130	x 13	B2
88.9	x 114.3	x 12.7	RP	95.25	x 133.35x 15.88		B1*	110	x 130	x 13	RP
88.9	x 127	x 12.7	B1*	100	x 115	x 9	B1	110	x 135	x 13	RP
90	x 105	x 10	R*	100	x 115	x 9	R	110	x 140	x 10	R
90	x 110	x 8	B1	100	x 120	x 8	B1*	110	x 140	x 12	R
90	x 110	x 10	RP	100	x 120	x 10	B1	110	x 140	x 13	B2
90	x 110	x 12	BA	100	x 120	x 10	BA	110	x 140	x 13	BA
90	x 110	x 12	R	100	x 120	x 10	R	110	x 140	x 13	R
90	x 110	x 12	RP	100	x 120	x 12	BA	110	x 150	x 13	B2
90	x 110	x 13	B1SL	100	x 120	x 12	R	110	x 150	x 13	R
90	x 110	x 13	B2	100	x 120	x 12	RP	110	x 150	x 15	B2
90	x 110	x 13	R	100	x 120	x 13	B2	111.1	x 136.52x 11.1		B1*
90	x 110	x 13	RP	100	x 120	x 13	R	111.1	x 152.4	x 12.7	B1*
90	x 115	x 9	B2	100	x 125	x 12	R	111.1	x 152.4	x 19.05	B1*
90	x 115	x 9	R*	100	x 125	x 13	B2	112	x 140	x 13	B2
90	x 115	x 10	R	100	x 125	x 13	BA	112	x 140	x 13	R
90	x 115	x 13	R	100	x 125	x 13	R	114	x 140	x 13	B2
90	x 115	x 13	RP	100	x 125	x 13	RP	114.3	x 152.4	x 19.05	B1*
90	x 120	x 12	R	100	x 130	x 10	BA	115	x 130	x 12	R
90	x 120	x 12	RP	100	x 130	x 12	BA	115	x 140	x 10	R
90	x 120	x 13	B2	100	x 130	x 12	R	115	x 140	x 12	BA
90	x 120	x 13	BA	100	x 130	x 12	RP	115	x 140	x 12	R
90	x 120	x 13	R	100	x 130	x 13	B2	115	x 140	x 12	RP
90	x 120	x 13	RP	100	x 130	x 13	B2SL	115	x 140	x 13	B2
90	x 125	x 12	RP	100	x 130	x 13	R	115	x 140	x 13	R
90	x 125	x 13	B2	100	x 130	x 13	R-DUO	115	x 140	x 13	RP
90	x 125	x 13	RP	100	x 130	x 15	B2	115	x 150	x 12	R
90	x 130	x 12	R	100	x 135	x 12	RP	115	x 150	x 13	B2
90	x 130	x 13	B2	100	x 140	x 13	B2	115	x 150	x 15	B2
90	x 130	x 13	R	100	x 140	x 13	R	115	x 160	x 15	R*
90	x 140	x 13	B2	100	x 150	x 13	R	117.47	x 149.22x 15.88		R*
92	x 120	x 13	B2	100	x 160	x 12	R	118	x 140	x 13	B2
92	x 120	x 13	R	100	x 185	x 13	R*	118	x 150	x 13	B2
92	x 125	x 13	B2*	101.6	x 127	x 12.7	B1*	118	x 160	x 15	B2
92.08	x 114.3	x 12.7	B1*	101.6	x 133.35x 15.88		B1*	120	x 140	x 13	B2
95	x 110	x 9	B1	105	x 125	x 10	R*	120	x 140	x 13	R
95	x 110	x 10	R	105	x 125	x 13	B2	120	x 140	x 13	RP
95	x 110	x 12	R	105	x 125	x 13	R	120	x 150	x 10	R
95	x 110	x 12	R-DUO*	105	x 125	x 13	RP	120	x 150	x 12	BA
95	x 115	x 13	B2	105	x 130	x 12	R	120	x 150	x 12	R
95	x 115	x 13	R	105	x 130	x 12	RP	120	x 150	x 12	RP
95	x 115	x 13	RP	105	x 130	x 13	B1SL	120	x 150	x 13	B2
95	x 120	x 10	RP	105	x 130	x 13	B2	120	x 150	x 13	R
95	x 120	x 12	R	105	x 130	x 13	R	120	x 150	x 15	B2
95	x 120	x 12	RP	105	x 130	x 13	RP*	120	x 150	x 15	RP
95	x 120	x 13	B2	105	x 135	x 13	R*	120	x 160	x 12	R
95	x 120	x 13	B2SL	105	x 140	x 12	R	120	x 160	x 13	B2
95	x 120	x 13	R	105	x 140	x 13	B2	120	x 160	x 15	B2
95	x 120	x 13	RP	105	x 140	x 13	R	120	x 160	x 15	R*
95	x 125	x 12	R	105	x 150	x 15	B2	120	x 170	x 15	B2*
95	x 125	x 12	RP	107	x 130	x 13	B2	120.65	x 146.05x 12.7		B1*
95	x 125	x 13	B2	107.95	x 133.35x 15.88		B1*	122	x 150	x 13	R
95	x 125	x 13	R	107.95	x 152.4	x 19.05	B1*	125	x 140	x 10	R*
95	x 130	x 12	R	108	x 130	x 13	B2	125	x 143	x 13	RP*
95	x 130	x 13	B2	108	x 140	x 13	B2	125	x 150	x 12	R
95	x 130	x 13	RP	110	x 128	x 9	B1	125	x 150	x 12	RP
95	x 135	x 13	R*	110	x 130	x 8	R*	125	x 150	x 13	B2
95	x 160	x 15	R*	110	x 130	x 12	BA	125	x 150	x 13	R
95.25	x 114.3	x 12.7	B1*	110	x 130	x 12	R	125	x 150	x 15	B2
95.25	x 120.65x 12.7		R*	110	x 130	x 12	RP	125	x 150	x 15	R

## Oliekeerringen NBR DIN 3760

d	D	h	type	d	D	h	type	d	D	h	type
125	x 152.4	x 15	B2	145	x 165	x 13	R	170	x 200	x 13	R
125	x 155	x 12	RP	145	x 167	x 13	RP	170	x 200	x 15	B2
125	x 160	x 12	R	145	x 170	x 13	B2	170	x 200	x 15	R
125	x 160	x 13	B2	145	x 170	x 13	R	170	x 200	x 15	RP
125	x 160	x 13	R	145	x 170	x 15	B2	170	x 215	x 16	B2
125	x 160	x 15	B2	145	x 170	x 15	R	175	x 200	x 15	B2
125	x 160	x 15	R	145	x 175	x 15	R*	175	x 200	x 15	R
127	x 152.4	x 12.7	R*	145	x 175	x 15	RP	175	x 210	x 14	R*
128	x 150	x 13	R	145	x 180	x 12	R	175	x 215	x 16	B2
130	x 150	x 10	R	145	x 180	x 13	R*	178	x 215	x 16	B2
130	x 150	x 12	RP	145	x 180	x 15	B2	180	x 200	x 13	R
130	x 155	x 10	B2	145	x 190	x 15	B2	180	x 200	x 15	B2
130	x 160	x 12	R	148	x 170	x 14.5	B2SL	180	x 200	x 15	R
130	x 160	x 12	RP	148	x 170	x 14.5	R	180	x 200	x 15	RP
130	x 160	x 13	B2	148	x 170	x 15	B2	180	x 210	x 15	B2
130	x 160	x 13	BA	148	x 180	x 15	B2	180	x 210	x 15	R
130	x 160	x 13	R	150	x 168	x 13	B1	180	x 210	x 15	RP
130	x 160	x 13	RP	150	x 170	x 12	R	180	x 215	x 15	B2SL
130	x 160	x 15	B2	150	x 170	x 15	B2	180	x 215	x 15	RP
130	x 160	x 15	R	150	x 180	x 12	R	180	x 215	x 16	B2
130	x 160	x 15	RP	150	x 180	x 13	B2	180	x 215	x 16	R
130	x 165	x 13	B2	150	x 180	x 13	BA	180	x 220	x 15	R
130	x 170	x 12	R*	150	x 180	x 13	R	180	x 220	x 16	B2
130	x 170	x 13	B2	150	x 180	x 13	RP	185	x 210	x 13	BA
130	x 180	x 15	B2	150	x 180	x 15	B2	185	x 210	x 13	RP
130	x 170	x 15	B2	150	x 180	x 15	R	185	x 215	x 15	B2
130	x 170	x 15	RP*	150	x 180	x 15	RP*	185	x 215	x 16	R*
130	x 180	x 15	B2	150	x 190	x 15	B2	190	x 215	x 16	B2
130	x 182	x 16	R	150	x 200	x 15	B2	190	x 215	x 16	RP*
132	x 160	x 13	B2*	155	x 175	x 12	R	190	x 220	x 15	B2
135	x 150	x 15	R	155	x 180	x 15	B2	190	x 220	x 15	R
135	x 160	x 12	R	155	x 180	x 15	RP	190	x 225	x 16	BA
135	x 160	x 13	B2	155	x 190	x 15	B2	190	x 225	x 16	RP
135	x 160	x 13	R	155	x 190	x 15	R	190	x 230	x 16	B2
135	x 160	x 15	B2	158	x 180	x 15	B2	190	x 230	x 16	RP*
135	x 165	x 13	B2	160	x 180	x 10	RP	195	x 220	x 16	B2
135	x 165	x 14	RP	160	x 180	x 15	B2	195	x 230	x 15	B2
135	x 170	x 12	R	160	x 185	x 10	B1	200	x 225	x 15	R
135	x 170	x 12	RP*	160	x 185	x 10	R	200	x 230	x 13	R
135	x 170	x 15	B2	160	x 190	x 13	B2	200	x 230	x 15	B2
140	x 160	x 13	B2	160	x 190	x 13	R	200	x 230	x 15	R*
140	x 160	x 13	R	160	x 190	x 15	B2	200	x 240	x 15	R
140	x 160	x 13	Sil.*	160	x 190	x 15	B2SL	200	x 250	x 15	B2
140	x 160	x 15	B2	160	x 190	x 15	R	200	x 250	x 15	R
140	x 165	x 12	BA	160	x 190	x 15	RP	205	x 230	x 16	R
140	x 165	x 12	R	160	x 200	x 12	R	205	x 250	x 18	R*
140	x 165	x 15	B2	160	x 200	x 15	B2	210	x 240	x 15	B2
140	x 170	x 12	R	160	x 200	x 15	RP	210	x 240	x 15	R
140	x 170	x 12	R*	165	x 190	x 13	B1SL	210	x 250	x 15	R
140	x 170	x 13	B2	165	x 190	x 13	B2	210	x 250	x 16	B2
140	x 170	x 13	BA	165	x 190	x 13	BA	215	x 240	x 12	BA
140	x 170	x 15	B2	165	x 190	x 13	R	215	x 250	x 16	B2
140	x 170	x 15	BA	165	x 190	x 15	B2	220	x 250	x 15	B2
140	x 170	x 15	R	165	x 190	x 15	RP	220	x 250	x 15	R
140	x 170	x 15	RP	165	x 200	x 15	B2	220	x 260	x 15	RP
140	x 180	x 12	R	170	x 190	x 13	RP	220	x 260	x 16	R
140	x 180	x 15	B2	170	x 190	x 15	B2	220	x 270	x 15	B2*
140	x 180	x 15	R	170	x 190	x 15	R	225	x 270	x 16	B2
140	x 190	x 12	R*	170	x 200	x 12	R	230	x 260	x 15	B2
145	x 165	x 13	B2*	170	x 200	x 13	B2	230	x 260	x 15	R

## Oliekeerringen NBR DIN 3760

d	D	h	type	d	D	h	type	d	D	h	type
230	x 260	x 15	RP*	380	x 430	x 19	B2 NIF				
230	x 270	x 15	B2	390	x 430	x 18	B2 NIF				
230	x 270	x 15	RP*	390	x 430	x 20	R				
230	x 280	x 15	R*	394	x 420	x 16	R				
230	x 280	x 16	B2*	400	x 440	x 20	B2				
235	x 270	x 16	B2	400	x 440	x 20	R				
240	x 270	x 15	B2	400	x 450	x 25	R				
240	x 270	x 15	R	420	x 460	x 20	B2 NIF				
240	x 280	x 15	R	420	x 460	x 20	R				
240	x 280	x 16	B2	420	x 470	x 20	RP				
240	x 290	x 16	B2*	440	x 470	x 20	B2				
245	x 270	x 16	B2	440	x 480	x 20	B2				
250	x 280	x 15	R	440	x 480	x 20	R				
250	x 280	x 16	B2	450	x 500	x 22	R				
250	x 290	x 16	B2	480	x 520	x 20	R				
260	x 290	x 15	RP*	500	x 540	x 20	B2				
260	x 290	x 16	B2	500	x 540	x 20	R				
260	x 300	x 20	B2	660	x 700	x 20	R				
260	x 300	x 20	R								
260	x 310	x 16	B2								
265	x 290	x 16	B2*								
265	x 290	x 16	R								
265	x 310	x 16	B2								
270	x 300	x 15	R*								
270	x 310	x 16	B2								
275	x 310	x 16	B2								
280	x 310	x 15	R								
280	x 310	x 16	B2								
280	x 320	x 20	B2								
280	x 320	x 20	R								
285	x 310	x 16	B2								
285	x 325	x 16	B1*								
290	x 330	x 18	B2								
295	x 335	x 18	B2								
300	x 332	x 16	B2 NIF*								
300	x 335	x 18	B2 NIF*								
300	x 340	x 16	BA NIF*								
300	x 340	x 18	R								
300	x 340	x 20	R*								
315	x 355	x 18	B2*								
320	x 350	x 18	B2								
320	x 360	x 18	B2 NIF*								
320	x 360	x 18	RP*								
320	x 360	x 20	R								
330	x 370	x 18	R								
340	x 380	x 18	B2 NIF								
340	x 380	x 18	R								
350	x 380	x 16	B2								
350	x 380	x 16	RP								
350	x 390	x 18	B2								
350	x 390	x 18	R								
360	x 390	x 15	RP								
360	x 400	x 18	B2								
360	x 400	x 20	B2								
360	x 400	x 20	R								
365	x 405	x 18	B2 NIF								
370	x 410	x 15	R								
380	x 420	x 20	B2 NIF								
380	x 420	x 20	R								
380	x 420	x 20	RP								

### Opmerkingen Oliekeerringen

- 1 De geleverde VITON® oliekeerringen worden in Europa gefabriceerd in speciaal voor VITON® geprepareerde matrijzen. Veel aangeboden VITON® oliekeerringen worden gemaakt in dezelfde matrijs als de NBR oliekeerring. Dit kan tot gevolg hebben dat het VITON® materiaal na verloop van tijd gaat loslaten van de koolstofstalenring met alle gevolgen van dien. Uiteraard verschillen deze uitvoeringen van prijs.
- 2 Naast het genoemde assortiment is de voorraad gecompleteerd met ontbrekende maten van andere fabrikanten, zoals Stefa, Rolf e.a.
- 3 De met een \* gemerkte keerringen zijn een complementering van het assortiment van diverse verschillende merken. De prijs en/of korting op deze keerringen kan afwijken van de standaard afspraken.
- 4 De met \* gemerkte oliekeerringen kunnen zonder voorafgaande kennisgeving uit productie worden genomen, of in prijs worden verhoogd!
- 5 De Viton® oliekeerringen worden standaard geleverd met een roestvast stalen veer. Deze roestvrije veren zijn ook los verkrijgbaar.

**Oliekeerringen FPM DIN 3760**

**Viton® oliekeerringen**

d	D	h	type	d	D	h	type	d	D	h	type
4	x 8	x 2	Rzv	15	x 42	x 7	R*	22	x 47	x 7	R
4	x 11	x 6	R*	15.88	x 28.58	x 6.35	R*	24	x 35	x 7	R*
4	x 12	x 6	R	16	x 22	x 3	Rzv	24	x 37	x 7	R
5	x 9	x 2	Rzv	16	x 24	x 3	Rzv	24	x 40	x 7	R
5	x 16	x 7	R*	16	x 24	x 4	R	25	x 32	x 4	Rzv
6	x 10	x 2	Rzv	16	x 26	x 7	R	25	x 32	x 6	R*
6	x 15	x 4	R*	16	x 28	x 7	R	25	x 33	x 6	R
6	x 16	x 6	R	16	x 28	x 7	RP	25	x 35	x 4	Rzv
6	x 16	x 7	R	16	x 30	x 7	R	25	x 35	x 7	R
6	x 19	x 6	R	16	x 30	x 10	R	25	x 35	x 7	RP
6	x 22	x 7	R	17	x 23	x 3	Rzv	25	x 37	x 5	R
6.35	x 15.88	x 4.76	R*	17	x 26	x 6	R*	25	x 38	x 7	R
6.35	x 19.05	x 6.35	R*	17	x 28	x 6	RP	25	x 40	x 5	R
7	x 11	x 2	Rzv	17	x 28	x 7	R	25	x 40	x 7	R
7	x 14	x 2	Rzv	17	x 28	x 7	RP*	25	x 40	x 7	RP
7	x 16	x 7	R	17	x 30	x 7	R	25	x 40	x 10	R
7	x 22	x 7	R	17	x 30	x 7	RP	25	x 42	x 7	R
8	x 12	x 3	Rzv	17	x 32	x 7	R	25	x 42	x 7	RP*
8	x 16	x 7	R	17	x 35	x 7	R	25	x 42	x 10	R
8	x 18	x 5	R	17	x 35	x 10	R	25	x 45	x 7	R
8	x 22	x 7	R	17	x 40	x 7	R	25	x 45	x 10	R
8	x 24	x 7	R	17	x 47	x 7	R*	25	x 47	x 7	R
9	x 22	x 7	R*	18	x 24	x 3	Rzv	25	x 47	x 8	R
9	x 24	x 7	R*	18	x 26	x 4	Rzv	25	x 47	x 10	R
10	x 19	x 7	R	18	x 28	x 7	R	25	x 50	x 10	R
10	x 20	x 6	RP	18	x 30	x 7	R	25	x 52	x 7	R
10	x 22	x 7	R	18	x 30	x 7	RP	25	x 52	x 7	RP
10	x 24	x 7	R	18	x 32	x 7	R	25	x 52	x 10	R
10	x 26	x 7	R	18	x 35	x 7	RP	25	x 62	x 7	R
10	x 28	x 7	R	18	x 40	x 7	R*	25	x 62	x 10	R
10	x 30	x 7	R*	19	x 27	x 4	Rzv	26	x 42	x 7	RP
11	x 22	x 7	R	19.05	x 31.75	x 6.35	RP*	26	x 47	x 7	R
12	x 16	x 3	Rzv	20	x 26	x 4	Rzv	27	x 37	x 7	R*
12	x 18	x 3	Rzv	20	x 28	x 4	Rzv	28	x 35	x 4	Rzv
12	x 19	x 5	R*	20	x 30	x 5	R	28	x 38	x 7	R
12	x 22	x 4	R	20	x 30	x 7	R	28	x 40	x 7	R
12	x 22	x 7	R	20	x 30	x 7	RP	28	x 45	x 7	R
12	x 22	x 7	RP	20	x 32	x 7	R	28	x 47	x 7	R
12	x 24	x 7	R	20	x 33	x 10	R	28	x 47	x 8	B1
12	x 24	x 7	RP	20	x 35	x 7	R	28	x 47	x 10	R
12	x 28	x 7	R	20	x 35	x 7	RP	28	x 50	x 10	R
12	x 30	x 7	R	20	x 35	x 10	R	28	x 52	x 7	R
12	x 30	x 10	R	20	x 38	x 8	R*	30	x 40	x 5	R*
13	x 30	x 7	R	20	x 40	x 7	R	30	x 40	x 7	R
14	x 22	x 4	R*	20	x 40	x 7	RP	30	x 40	x 7	RP*
14	x 24	x 7	R*	20	x 40	x 10	R	30	x 42	x 7	R
14	x 27	x 7	R	20	x 42	x 7	R	30	x 42	x 7	RP*
14	x 30	x 7	R	20	x 42	x 7	RP*	30	x 45	x 7	R
15	x 21	x 3	Rzv	20	x 42	x 10	R	30	x 45	x 8	R
15	x 24	x 5	R	20	x 47	x 7	R	30	x 45	x 10	R
15	x 24	x 7	R	20	x 47	x 10	R	30	x 47	x 7	R
15	x 24	x 7	RP	20	x 52	x 7	R	30	x 47	x 7	RP
15	x 26	x 7	R	20	x 52	x 10	R	30	x 47	x 10	R
15	x 26	x 7	RP	22	x 30	x 4	Rzv	30	x 50	x 7	R
15	x 28	x 5	R*	22	x 30	x 7	R	30	x 50	x 10	R
15	x 28	x 7	R	22	x 32	x 7	R	30	x 50	x 10	RP
15	x 30	x 7	R	22	x 35	x 7	R	30	x 52	x 7	R
15	x 30	x 10	R	22	x 38	x 7	R	30	x 52	x 10	R
15	x 32	x 7	R	22	x 40	x 7	R	30	x 55	x 10	R
15	x 35	x 7	R	22	x 40	x 10	R*	30	x 56	x 10	R

**Oliekeerringen FPM DIN 3760**

**Viton® oliekeerringen**

d	D	h	type	d	D	h	type	d	D	h	type
30	x 62	x 7	R	40	x 68	x 10	R	50	x 75	x 10	R
30	x 62	x 10	R	40	x 70	x 10	R	50	x 80	x 8	R
30	x 72	x 8	RP*	40	x 72	x 7	R	50	x 80	x 10	R
31	x 47	x 7	RP*	40	x 72	x 10	R	50	x 80	x 13	RP
32	x 45	x 7	R	40	x 80	x 10	R	50	x 90	x 10	R
32	x 47	x 7	R	40	x 85	x 10	R	52	x 62	x 8	RP*
32	x 47	x 7	RP	42	x 55	x 7	RP	52	x 68	x 8	R
32	x 48	x 8	R	42	x 55	x 8	R	52	x 72	x 8	R
32	x 50	x 10	R	42	x 56	x 7	R	52	x 72	x 8	RP
32	x 52	x 7	RP*	42	x 56	x 7	RP	52	x 72	x 10	R
32	x 52	x 10	R	42	x 60	x 10	R	52	x 75	x 10	R
33	x 45	x 7	R	42	x 62	x 7	R	52	x 75	x 12	RP*
35	x 42	x 4	Rzv	42	x 62	x 10	RP*	54	x 70	x 12	R
35	x 45	x 4	Rzv	42	x 65	x 10	RP*	55	x 63	x 5	Rzv
35	x 45	x 7	R	42	x 68	x 8	R	55	x 68	x 8	RP*
35	x 47	x 7	R	42	x 72	x 8	R	55	x 70	x 8	R
35	x 47	x 7	RP	42	x 72	x 10	R	55	x 70	x 8	RP
35	x 50	x 7	R	45	x 52	x 4	Rzv	55	x 70	x 10	R
35	x 50	x 8	RP*	45	x 55	x 4	Rzv	55	x 72	x 8	R
35	x 50	x 10	R	45	x 55	x 7	R	55	x 72	x 8	RP
35	x 52	x 7	R	45	x 60	x 7	R	55	x 72	x 10	R
35	x 52	x 10	R	45	x 60	x 8	R	55	x 72	x 10	RP
35	x 55	x 10	R	45	x 60	x 10	R	55	x 75	x 10	R
35	x 56	x 10	R	45	x 62	x 7	R	55	x 75	x 12	R
35	x 62	x 7	R	45	x 62	x 8	R	55	x 80	x 8	R
35	x 62	x 7	RP	45	x 62	x 8	RP*	55	x 80	x 10	R
35	x 62	x 10	R	45	x 62	x 10	R	55	x 85	x 8	R
35	x 68	x 10	R	45	x 65	x 8	R	55	x 90	x 10	R
35	x 72	x 10	R	45	x 65	x 8	RP	58	x 72	x 8	R
36	x 47	x 7	R	45	x 65	x 10	R	58	x 72	x 10	R
36	x 48	x 10	R	45	x 66	x 6	R	58	x 80	x 8	R
36	x 50	x 7	R	45	x 68	x 10	R	58	x 80	x 10	R
36	x 52	x 7	RP	45	x 70	x 12	R	60	x 72	x 8	R
36	x 54	x 7.5	RP*	45	x 72	x 8	R	60	x 75	x 8	R
36	x 62	x 7	RP	45	x 72	x 10	R	60	x 75	x 8	RP
37	x 52	x 10	RP*	45	x 75	x 10	R	60	x 75	x 10	R
38	x 50	x 7	R	45	x 80	x 10	R	60	x 78	x 10	R
38	x 52	x 7	R	45	x 85	x 10	RP	60	x 80	x 8	R
38	x 54	x 6.5	R	48	x 62	x 8	R	60	x 80	x 10	R
38	x 55	x 7	RP*	48	x 62	x 8	RP	60	x 80	x 10	RP
38	x 56	x 10	R	48	x 65	x 10	R	60	x 80	x 12	RP
38	x 60	x 10	R	48	x 72	x 8	RP	60	x 85	x 8	R
38	x 62	x 7	RP*	48	x 72	x 10	R	60	x 85	x 10	R
38	x 62	x 10	R	48	x 80	x 10	R	60	x 85	x 10	RP
40	x 47	x 4	Rzv	50	x 58	x 4	Rzv	60	x 90	x 8	R
40	x 48	x 4	Rzv	50	x 62	x 7	R	60	x 90	x 10	R
40	x 52	x 7	R	50	x 65	x 8	R	60	x 90	x 13	R
40	x 52	x 7	RP	50	x 65	x 8	RP	60	x 95	x 10	RP*
40	x 55	x 7	R	50	x 65	x 10	R	60	x 110	x 13	RP*
40	x 55	x 7	RP	50	x 68	x 8	R	62	x 80	x 10	RP*
40	x 55	x 8	R	50	x 68	x 8	RP	62	x 85	x 10	R
40	x 55	x 8	RP	50	x 68	x 10	R	62	x 90	x 10	R
40	x 56	x 8	R	50	x 70	x 8	R	63	x 85	x 10	R
40	x 56	x 10	R	50	x 70	x 10	R	63	x 90	x 10	R
40	x 58	x 10	R	50	x 70	x 12	R	65	x 80	x 8	R
40	x 60	x 10	R	50	x 72	x 8	R	65	x 80	x 10	RP
40	x 62	x 7	R	50	x 72	x 10	R	65	x 85	x 8	R
40	x 62	x 7	RP	50	x 72	x 10	RP	65	x 85	x 10	R
40	x 62	x 10	R	50	x 72	x 12	R	65	x 85	x 13	RP
40	x 65	x 10	R	50	x 72	x 12	RP	65	x 90	x 10	R



d	D	h	type	d	D	h	type	d	D	h	type
65	x 90	x 10	RP	100	x 130	x 12	R	180	x 215	x 16	R
65	x 95	x 10	R	105	x 125	x 13	R	180	x 220	x 15	R
65	x 100	x 10	R	105	x 130	x 12	R	185	x 210	x 13	R
68	x 90	x 10	R	105	x 130	x 13	RP	185	x 215	x 16	R
68	x 100	x 10	R	105	x 140	x 12	R	190	x 220	x 15	R
70	x 85	x 8	R	110	x 130	x 12	R	190	x 225	x 16	RP
70	x 90	x 10	R	110	x 130	x 12	RP	200	x 230	x 13	R
70	x 90	x 10	RP	110	x 130	x 13	R	200	x 230	x 15	R
70	x 90	x 12	R	110	x 140	x 12	R	200	x 230	x 15	RP
70	x 90	x 13	R	110	x 140	x 13	R	200	x 250	x 15	R
70	x 95	x 10	R	115	x 130	x 12	R	205	x 230	x 16	R
70	x 100	x 10	R	115	x 140	x 12	R	210	x 240	x 15	R
70	x 100	x 10	RP	115	x 150	x 12	R*	210	x 250	x 15	R*
70	x 100	x 12	R	120	x 140	x 10	R	220	x 250	x 15	RP
70	x 100	x 13	R	120	x 140	x 13	R	220	x 260	x 16	R
70	x 110	x 10	R	120	x 150	x 12	R	230	x 260	x 15	R
72	x 85	x 10	R*	120	x 150	x 12	RP	230	x 280	x 15	R*
72	x 90	x 10	R*	120	x 150	x 13	R	240	x 270	x 15	R
72	x 95	x 10	R	120	x 150	x 15	RP	240	x 280	x 15	R*
72	x 100	x 10	R	120	x 160	x 12	R	250	x 280	x 15	R
75	x 90	x 8	R	120	x 160	x 15	R	260	x 300	x 20	R
75	x 90	x 10	R	125	x 150	x 12	R	265	x 290	x 16	R
75	x 95	x 10	R	125	x 150	x 12	RP	280	x 310	x 15	R*
75	x 95	x 10	RP	125	x 160	x 12	R	280	x 320	x 20	R
75	x 95	x 12	R	130	x 150	x 10	R	300	x 340	x 18	R
75	x 100	x 10	R	130	x 150	x 12	RP	320	x 360	x 20	R
75	x 100	x 10	RP	130	x 160	x 12	R	340	x 380	x 18	R
75	x 100	x 12	R	130	x 160	x 12	RP	350	x 390	x 18	R
75	x 110	x 12	R	130	x 160	x 13	R	360	x 400	x 20	RP
78	x 100	x 10	R	130	x 160	x 15	R	370	x 410	x 15	R
78	x 110	x 12	R*	130	x 170	x 12	R	380	x 420	x 20	R
80	x 90	x 5	Rzv	130	x 170	x 13	R*	390	x 430	x 20	R*
80	x 95	x 8	R	135	x 160	x 12	R*	400	x 440	x 20	R*
80	x 100	x 10	R	135	x 160	x 15	RP	420	x 460	x 20	R*
80	x 100	x 10	RP	135	x 170	x 12	R	420	x 470	x 20	RP
80	x 100	x 13	RP	140	x 165	x 12	R	440	x 480	x 20	R*
80	x 105	x 12	R	140	x 170	x 12	RP	450	x 500	x 22	R*
80	x 110	x 10	RP	140	x 170	x 15	R	480	x 520	x 20	R*
80	x 110	x 12	R	140	x 170	x 15	RP	500	x 540	x 20	R*
85	x 110	x 12	R	140	x 180	x 12	R				
85	x 110	x 12	RP	140	x 180	x 15	R				
85	x 120	x 12	R	145	x 170	x 15	RP				
85	x 130	x 13	RP*	145	x 175	x 15	R				
90	x 110	x 12	R	145	x 175	x 15	RP				
90	x 110	x 12	RP	145	x 180	x 12	R				
90	x 115	x 12	R	145	x 180	x 13	R				
90	x 120	x 12	R	150	x 170	x 12	R				
92	x 120	x 13	R	150	x 180	x 13	R				
95	x 110	x 10	R	150	x 180	x 15	R				
95	x 110	x 12	R	160	x 185	x 10	R				
95	x 115	x 13	RP	160	x 190	x 15	R				
95	x 120	x 12	R	160	x 190	x 15	RP				
95	x 120	x 13	RP	165	x 190	x 13	R				
95	x 125	x 12	R	170	x 190	x 15	R				
100	x 115	x 9	RP*	170	x 200	x 12	R				
100	x 120	x 12	R	170	x 200	x 15	R				
100	x 120	x 12	RP	175	x 200	x 15	R				
100	x 120	x 13	R	175	x 210	x 14	R				
100	x 125	x 12	R	180	x 200	x 13	R				
100	x 125	x 13	R	180	x 210	x 15	R				

## SIMMERRING® - oliekeerringen GWBM

Met korte levertijden zijn wij in staat profielen in ringvorm te leveren door de uiteinden aan elkaar te vulkaniseren.

De massief rubbering met weefsel versterkte buitenmantel is voorzien van een rondlopende oliegroef met op regelmatige afstanden radiale groeven, waardoor het realiseren van een goede smering mogelijk wordt.

De buitenmantel en de breedte worden met een overmaat uitgevoerd teneinde radiaal en axiaal een goede dichting te verkrijgen.

De asafdichtingen type GWBM kunnen zowel eindloos als gedeeld geleverd worden.

### Toleranties

De tolerantie van de af te dichten as is volgens ISO h11.

De tolerantie van de op te nemen boring van de asafdichting is volgens ISO H11. De diepte van de inbouwruimte dient na het vastzetten van de spanflens overeen te komen met de nominale breedte (b) van de ring met een tolerantie van + 0,1 mm.

### Maattabellen

De radiale-asafdichtingen type GWBM kunnen uit bestaande matrijzen in vier geometrische gelijksoortige profielen voor iedere asdiameter van 230 tot 1500 mm geleverd worden.

De tabel bevat de belangrijkste nominale maten van de afzonderlijke profielen.

Uit de diameter d1 van de af te dichten as en uit de profielmaten T en b volgen de bestelmaten van de gewenste ring.

Daarbij geldt voor de nominale buitendiameter van de ringen  $d_2 = d_1 + 2T$ .

Wordt bijvoorbeeld een asafdichting GWBM voor een as van 600 mm gewenst, dan zijn de volgende ringen leverbaar:

- profiel 1: 600 x 640 x 18
- profiel 2: 600 x 644 x 20
- profiel 3: 600 x 650 x 22
- profiel 4: 600 x 664 x 25

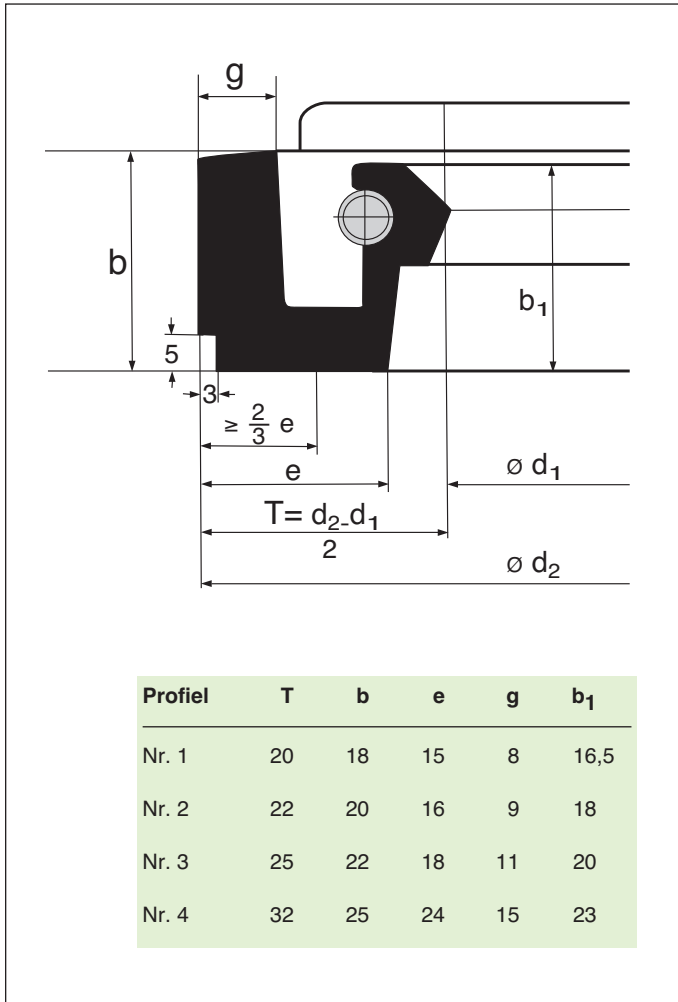

## Precisie O-ringen NBR 70 - FPM 75

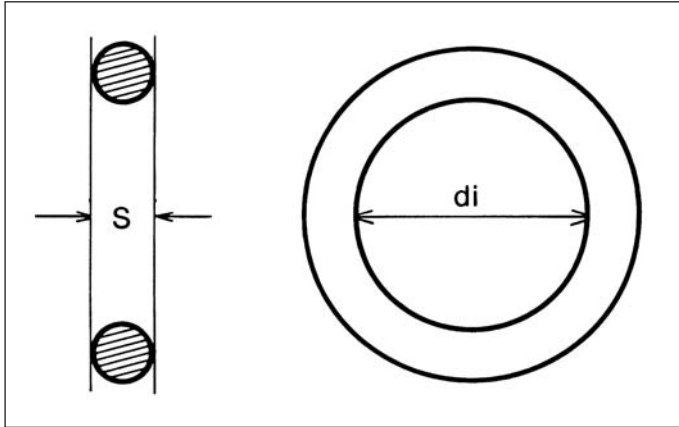

De O-ring is van huis uit een uiterst precisie onderdeel met een zeer hoge maatnauwkeurigheid, maar wordt inmiddels ook buiten de doelgroep waarvoor hij ontwikkeld is veelvuldig toegepast.

Door zijn geringe inbouwmaten en relatief lage prijs kan men de O-ring zowat overal inpassen.

Voor de techniek is de O-ring in principe bedoeld als statische afdichting, hij kan echter ook bij een lage druk en lagere schuifsnelheden dynamisch worden gebruikt.

De O-ringen die grotendeels worden vervaardigd volgens bepaalde normen kunnen in diverse materiaalsoorten en hardheden geleverd worden.

Hieronder een overzicht van de meest voorkomende materialen die wij uit voorraad leveren.

Kwaliteit	Basismateriaal	Hardheid	Temperatuurbereik	Bestand tegen o.a.
NBR 70	Nitrilbutadeen	70 ± 5	- 30 + 120°C	Minerale olie en vetten, water, alcohol, acetyleen
NBR 90	Nitrilbutadeen	90 ± 5	- 30 + 120°C	Als 70 shore echter voor hogere druk
FPM	Fluorkoolstof elastomeer	75 ± 5	- 30 + 200°C	Synthetische en hydraulische vloeistof, zoutzuur, dieselolie, benzine
SIL	Siliconen rubber	75 ± 5	- 60 + 220°C	Water, lucht, zuurstof, heet water, diverse chemicaliën
EPDM	ethyleen-propyleen	70 ± 5	- 50 + 130°C	Oplosmiddelen, heet water en stoom
NEOPRENE®		70 ± 5	- 35 + 110°C	Ozon en verouderingsbestendig
PTFE	zuiver teflon		- 160 + 230°C	Verdunde zuurstofoplossingen, geconcentreerd zoutzuur, vloeibaar ammonia
KALREZ®			- 30 + 275°C	Speciaal voor de chemische industrie

### Druk

Bij een statische toepassing is de toelaatbare druk bijna onbeperkt indien de groefconstructie zo is uitgevoerd dat extrusie wordt voorkomen.

Ook de hardheid van de O-ring is van invloed op het functioneren ervan. Bij een lagere druk voldoet een zachtere kwaliteit beter dan de 90 shore O-ring.

Bij een druk van boven de 100 bar adviseren wij een back-up ring te gebruiken.

Door gebruik te maken van de Seal-Jet is het mogelijk haast elke back-up ring binnen zeer korte tijd te leveren.

### Smering

Bij dynamische toepassing slijt de O-ring snel als niet wordt gesmeerd.

Bij pneumatische toepassing dient de O-ring te worden gevet en moet ook de groef met vet worden gevuld.

(Zie ons speciaal vet op pagina 5.)

Bij hydraulische toepassing geeft de vloeistof vaak zelf voldoende smering.

Bij statische toepassingen dient een eventuele smering alleen om montage en demontage te vereenvoudigen.

## Groefafmetingen O-ringen in mm

Afmetingen en toleranties vindt u in de onderstaande tabel. Voor Teflon O-ringen gelden andere groefafmetingen.

snoer Ø	dynamisch				statisch			
	schuivend		draaiend		flensafdichting		andere afdichting	
	diepte + 0,00 - 0,05	breedte + 0,10 - 0,00	diepte + 0,00 - 0,05	breedte + 0,10 - 0,00	diepte + 0,00 - 0,05	breedte + 0,10 - 0,00	diepte + 0,00 - 0,05	breedte + 0,10 - 0,00
0.41	0.34	0.55	0.34	0.48	0.28	0.61	0.31	0.50
0.45	0.37	0.61	0.37	0.53	0.31	0.67	0.34	0.55
0.6	0.49	0.81	0.49	0.70	0.41	0.89	0.45	0.74
0.65	0.53	0.88	0.53	0.76	0.44	0.97	0.49	0.80
0.7	0.57	0.95	0.57	0.83	0.48	1.04	0.53	0.86
0.75	0.62	1.01	0.62	0.88	0.51	1.12	0.57	0.92
0.8	0.72	1.08	0.72	0.94	0.54	1.20	0.63	0.98
0.9	0.81	1.25	0.81	1.05	0.61	1.35	0.71	1.11
1.0	0.81	1.57	0.81	1.20	0.68	1.50	0.75	1.25
1.02	0.81	1.57	0.81	1.20	0.69	1.52	0.75	1.25
1.2	1.00	1.80	1.00	1.40	0.82	1.80	0.91	1.48
1.25	1.04	1.85	1.04	1.45	0.85	1.85	0.95	1.54
1.27	1.04	1.85	1.04	1.45	0.86	1.90	0.95	1.56
1.3	1.10	1.90	1.10	1.50	0.88	1.95	0.99	1.60
1.36	1.16	1.95	1.16	1.60	0.92	2.05	1.04	1.67
1.42	1.16	2.08	1.16	1.60	0.97	2.10	1.07	1.75
1.45	1.20	2.10	1.20	1.70	0.99	2.16	1.10	1.78
1.47	1.20	2.10	1.20	1.70	1.00	2.19	1.10	1.81
1.5	1.24	2.15	1.24	1.70	1.02	2.24	1.13	1.85
1.52	1.24	2.16	1.24	1.70	1.03	2.25	1.14	1.87
1.6	1.30	2.20	1.30	2.10	1.10	2.25	1.20	1.97
1.63	1.30	2.20	1.30	2.10	1.12	2.25	1.21	2.00
1.78	1.45	2.40	1.45	2.30	1.20	2.42	1.33	2.19
1.83	1.50	2.45	1.50	2.35	1.26	2.49	1.38	2.25
1.9	1.55	2.55	1.55	2.40	1.40	2.58	1.48	2.34
1.98	1.60	2.70	1.60	2.50	1.50	2.69	1.55	2.44
2.0	1.60	2.70	1.60	2.50	1.50	2.72	1.55	2.46
2.2	1.80	3.00	1.80	2.55	1.70	2.99	1.75	2.71
2.21	1.80	3.00	1.80	2.55	1.70	3.01	1.75	2.72
2.4	2.10	3.25	2.10	2.70	1.90	3.26	2.00	2.95
2.46	2.15	3.30	2.15	2.75	1.95	3.35	2.05	3.03
2.5	2.20	3.40	2.20	2.80	2.00	3.40	2.10	3.08
2.62	2.30	3.60	2.30	2.90	2.10	3.56	2.20	3.22
2.7	2.40	3.65	2.40	3.05	2.15	3.67	2.28	3.32
2.95	2.65	4.05	2.65	3.35	2.35	4.01	2.50	3.63
3.0	2.65	4.05	2.65	3.35	2.40	4.08	2.53	3.69
3.15	2.85	4.25	2.85	3.50	2.50	4.23	2.68	3.87
3.2	2.85	4.25	2.85	3.50	2.55	4.35	2.70	3.94
3.25	2.95	4.35	2.95	3.60	2.60	4.42	2.78	4.00
3.3	3.00	4.46	3.00	3.86	2.65	4.49	2.83	4.06
3.5	3.15	4.75	3.15	4.10	2.80	4.76	2.98	4.31
3.53	3.15	4.75	3.15	4.10	2.80	4.80	2.98	4.34
3.6	3.25	4.85	3.25	4.20	2.90	4.90	3.08	4.43
4.0	3.55	5.40	3.55	4.68	3.20	5.44	3.38	4.92
4.5	4.00	6.10	4.00	5.30	3.60	6.12	3.80	5.54
5.0	4.40	6.75	4.40	5.85	4.15	6.80	4.28	6.15
5.33	4.80	7.20	4.80	5.85	4.45	7.48	4.75	6.77
5.7	5.13	7.70	5.13	6.65	4.75	7.75	4.94	7.01
6.0	5.40	8.10	5.40	6.70	5.00	8.16	5.20	7.38
6.5	5.85	8.80	5.85	7.50	5.40	8.84	5.63	8.00
6.99	6.10	9.45	6.10	8.05	5.80	9.51	5.95	8.60
7.0	6.10	9.45	6.10	8.05	5.80	9.52	5.95	8.61
7.5	6.40	10.10	6.40	8.65	6.25	10.20	6.33	9.23
8.0	7.20	10.80	7.20	8.90	6.65	10.88	6.93	9.84
8.4	7.55	11.35	7.55	9.25	7.00	11.42	7.23	10.33
8.5	7.60	11.50	7.60	9.80	7.05	11.56	7.33	10.46
9.0	8.10	12.15	8.10	10.55	7.45	12.24	7.78	11.07
9.5	8.40	12.85	8.40	11.10	7.90	12.92	8.15	11.69
10.0	9.00	13.50	9.00	11.70	8.30	13.60	8.65	12.30
10.5	9.45	14.20	9.45	12.10	8.70	14.28	9.08	12.90
11.0	9.90	14.85	9.90	12.65	9.15	14.96	9.53	13.53
12.0	10.80	16.20	10.80	13.80	9.95	16.32	10.38	14.76
13.0	11.70	17.55	11.70	14.95	10.80	17.68	11.25	15.99
14.0	12.60	18.90	12.60	16.10	11.60	19.04	11.83	17.22
15.0	13.50	20.25	13.50	17.25	12.45	20.40	12.98	18.45
16.0	14.40	21.60	14.40	18.40	13.45	21.76	13.93	19.68
17.0	15.30	22.95	15.30	19.40	14.30	23.12	14.80	20.91
18.0	16.20	24.30	16.20	20.50	15.10	24.48	15.65	22.14
19.0	17.10	25.65	17.10	21.85	16.15	25.84	16.63	23.37
20.0	18.00	27.00	18.00	23.00	17.00	27.20	17.50	24.60
21.0	18.90	28.35	18.90	24.15	17.85	28.55	18.38	25.83
22.0	19.80	29.70	19.80	25.30	18.70	29.90	19.25	27.06

## O-ringen NBR 70

afmetingen		afmetingen		afmetingen		afmetingen	
di	x s	di	x s	di	x s	di	x s
0.74	x 1.02	4	x 1.5	6.1	x 1.6	9	x 1.2
1	x 2	4	x 2	6.3	x 2.4	9	x 1.5
1.07	x 1.27	4	x 2.5	6.35	x 1.78	9	x 2
1.15	x 1	4	x 3	6.4	x 1.9	9	x 2.2
1.15	x 1.25	4	x 4	6.5	x 1	9	x 2.5
1.2	x 0.7	4	x 5	6.5	x 1.5	9	x 3
1.2	x 1	4	x 5.5	6.5	x 2	9	x 3.5
1.24	x 2.62	4.1	x 1.6	6.6	x 2.4	9	x 4
1.42	x 1.52	4.2	x 1.9	6.75	x 1.78	9	x 4.5
1.5	x 1	4.3	x 2.4	7	x 1	9	x 5
1.5	x 1.5	4.34	x 3.53	7	x 1.2	9	x 5.5
1.6	x 1	4.42	x 2.62	7	x 1.5	9	x 6
1.78	x 1.02	4.47	x 1.78	7	x 2	9	x 10
1.78	x 1.78	4.5	x 1	7	x 2.5	9.1	x 1.6
1.8	x 1	4.5	x 1.5	7	x 3	9.12	x 3.53
1.8	x 1.2	4.6	x 2	7	x 4	9.13	x 2.62
2	x 1	4.6	x 2.4	7	x 5	9.19	x 2.62
2	x 1.2	4.7	x 1.42	7	x 6	9.2	x 3
2	x 1.5	4.7	x 1.6	7.1	x 1.6	9.25	x 1.78
2.06	x 2.62	4.76	x 1.78	7.2	x 1.9	9.3	x 2.4
2.2	x 1	4.8	x 1.6	7.3	x 2.4	9.5	x 1
2.2	x 1.6	4.9	x 1.9	7.5	x 2	9.5	x 1.5
2.4	x 1.3	5	x 0.8	7.5	x 1	9.5	x 2
2.4	x 1.9	5	x 1	7.5	x 1.5	9.5	x 2.75
2.5	x 1	5	x 1.25	7.5	x 2.4	9.5	x 3
2.5	x 1.2	5	x 1.5	7.5	x 2.5	9.52	x 1.78
2.5	x 1.3	5	x 1.6	7.52	x 3.53	9.6	x 2.4
2.5	x 1.5	5	x 2	7.59	x 2.62	9.92	x 2.62
2.5	x 2	5	x 2.5	7.6	x 1.2	10	x 1
2.57	x 1.78	5	x 3	7.6	x 2.4	10	x 1.3
2.6	x 1	5	x 5	7.65	x 1.63	10	x 1.5
2.6	x 1.2	5.1	x 1	7.65	x 1.78	10	x 2
2.6	x 1.6	5.1	x 1.6	7.94	x 1.78	10	x 2.2
2.6	x 1.9	5.23	x 2.62	8	x 1	10	x 2.5
2.75	x 1.6	5.28	x 1.78	8	x 1.36	10	x 3
2.8	x 1.5	5.3	x 2.4	8	x 1.5	10	x 3.5
2.84	x 2.62	5.5	x 1	8	x 1.9	10	x 4
2.9	x 1.78	5.5	x 1.5	8	x 2	10	x 4.5
3	x 1	5.5	x 2.4	8	x 2.2	10	x 5
3	x 1.5	5.5	x 3	8	x 2.5	10	x 6
3	x 2	5.6	x 2.4	8	x 3	10	x 6.5
3	x 3	5.7	x 1.9	8	x 3.2	10	x 8
3.1	x 1.6	5.8	x 1.5	8	x 3.5	10.1	x 1.6
3.1	x 2.4	5.94	x 3.53	8	x 4	10.3	x 2.4
3.17	x 1.78	6	x 0.85	8	x 4.5	10.3	x 3.2
3.3	x 0.7	6	x 1	8	x 5	10.46	x 5.33
3.3	x 2.4	6	x 1.2	8	x 8	10.5	x 1.5
3.4	x 1.5	6	x 1.5	8.1	x 1.6	10.5	x 2.7
3.4	x 1.9	6	x 2	8.3	x 2.4	10.52	x 1.83
3.5	x 0.9	6	x 2.2	8.4	x 2.2	10.6	x 2.4
3.5	x 1	6	x 2.5	8.5	x 1	10.69	x 3.53
3.5	x 1.2	6	x 3	8.5	x 1.25	10.78	x 2.62
3.5	x 1.5	6	x 4	8.5	x 1.5	10.82	x 1.78
3.5	x 2	6	x 4.5	8.5	x 2	11	x 1
3.6	x 2.4	6	x 5.5	8.6	x 2.4	11	x 1.3
3.63	x 2.62	6	x 6	8.73	x 1.78	11	x 1.5
3.68	x 1.78	6	x 6.5	8.9	x 1.9	11	x 2
4	x 1	6.02	x 2.62	8.9	x 2.7	11	x 2.5
4	x 1.2	6.07	x 1.63	8.92	x 1.83	11	x 3
4	x 1.3	6.07	x 1.78	9	x 1	11	x 3.2

## O-ringen NBR 70

afmetingen		afmetingen		afmetingen		afmetingen	
di	x s	di	x s	di	x s	di	x s
11	x 3.5	13.46	x 2.08	16	x 6	18.6	x 2.4
11	x 4	13.5	x 2.5	16	x 7	18.64	x 3.53
11	x 5	13.6	x 2.4	16	x 8	18.72	x 2.62
11	x 5.5	13.6	x 2.7	16	x 10	18.77	x 1.78
11	x 6	13.64	x 5.33	16	x 12	19	x 1
11	x 7	13.87	x 3.53	16.1	x 1.6	19	x 1.2
11.1	x 1.6	13.94	x 2.62	16.3	x 2.4	19	x 1.5
11.11	x 1.78	14	x 1	16.36	x 2.21	19	x 2
11.3	x 2.4	14	x 1.5	16.47	x 1.45	19	x 2.5
11.5	x 1.5	14	x 1.78	16.5	x 1.5	19	x 2.75
11.5	x 2	14	x 2	16.6	x 2.4	19	x 3
11.5	x 2.5	14	x 2.5	16.8	x 2.2	19	x 3.5
11.5	x 3	14	x 3	16.82	x 5.33	19	x 4
11.6	x 2.4	14	x 3.5	16.9	x 2.7	19	x 5
11.89	x 1.98	14	x 4	17	x 0.6	19	x 7
11.91	x 2.62	14	x 5	17	x 0.8	19	x 9
12	x 1	14	x 8	17	x 1	19	x 10
12	x 1.5	14.1	x 1.6	17	x 1.2	19.1	x 1.6
12	x 2	14.3	x 2.4	17	x 1.5	19.18	x 2.46
12	x 2.2	14.5	x 2	17	x 2	19.2	x 3
12	x 2.5	14.5	x 2.5	17	x 2.5	19.3	x 2.4
12	x 3	14.5	x 3	17	x 3	19.5	x 1.5
12	x 3.5	15	x 1	17	x 4	19.5	x 2
12	x 4	15	x 1.5	17	x 4.5	19.5	x 3
12	x 4.5	15	x 2	17	x 5	19.6	x 2.4
12	x 5	15	x 2.5	17	x 5.5	19.8	x 3.6
12	x 5.5	15	x 3	17	x 6	19.99	x 5.33
12	x 6	15	x 3.2	17	x 7	20	x 1
12	x 7	15	x 3.5	17.04	x 3.53	20	x 1.3
12	x 8	15	x 4	17.1	x 1.3	20	x 1.5
12	x 10	15	x 4.5	17.1	x 1.6	20	x 2
12.07	x 5.33	15	x 5	17.12	x 2.62	20	x 2.5
12.1	x 1.6	15	x 6	17.17	x 1.78	20	x 3
12.1	x 2.7	15	x 7	17.2	x 3	20	x 3.5
12.29	x 3.53	15	x 10	17.3	x 2.4	20	x 4
12.3	x 2.4	15.08	x 2.62	17.5	x 1.5	20	x 4.5
12.37	x 2.62	15.1	x 1.6	17.5	x 2	20	x 5
12.42	x 1.78	15.1	x 2.7	17.5	x 2.5	20	x 5.5
12.5	x 2	15.24	x 5.33	17.6	x 2.4	20	x 6
12.5	x 2.5	15.3	x 2.4	17.86	x 2.62	20	x 6.5
12.5	x 2.75	15.47	x 3.53	17.93	x 2.46	20	x 8
12.5	x 3.5	15.5	x 1	18	x 1	20	x 10
12.6	x 2.4	15.5	x 2	18	x 1.3	20.2	x 3
12.7	x 2.62	15.5	x 3	18	x 1.5	20.22	x 3.53
13	x 1	15.5	x 3.5	18	x 2	20.29	x 2.62
13	x 1.25	15.54	x 2.62	18	x 2.2	20.3	x 2.4
13	x 1.5	15.6	x 1.78	18	x 2.5	20.35	x 1.78
13	x 2	15.6	x 2.4	18	x 3	20.5	x 2.4
13	x 2.5	15.88	x 2.62	18	x 3.5	20.64	x 2.62
13	x 3	16	x 1	18	x 4	21	x 1
13	x 3.2	16	x 1.2	18	x 5	21	x 1.5
13	x 3.5	16	x 1.25	18	x 6	21	x 2
13	x 4	16	x 1.5	18	x 7	21	x 2.5
13	x 4.5	16	x 2	18.1	x 1.6	21	x 3
13	x 5	16	x 2.5	18.3	x 2.4	21	x 4
13	x 6	16	x 3	18.3	x 3.6	21	x 5
13	x 8	16	x 3.5	18.4	x 2.7	21.2	x 1.9
13.1	x 2.62	16	x 4	18.42	x 5.33	21.3	x 2.4
13.1	x 1.6	16	x 5	18.5	x 1.5	21.3	x 3.6
13.3	x 2.4	16	x 5.5	18.5	x 2	21.5	x 3

## O-ringen NBR 70

afmetingen		afmetingen		afmetingen		afmetingen	
di	x s	di	x s	di	x s	di	x s
21.59	x 5.33	24.6	x 2.4	27	x 8	31	x 3.5
21.6	x 2.4	24.6	x 3	27.1	x 1.6	31	x 4
21.82	x 3.53	24.6	x 3.6	27.3	x 2.7	31	x 5
21.89	x 2.62	24.77	x 5.33	27.5	x 2.4	31	x 8
21.92	x 2.95	24.99	x 3.53	27.5	x 3	31.13	x 5.33
21.95	x 1.78	25	x 1	27.6	x 2.4	31.2	x 3
22	x 1	25	x 1.5	27.8	x 3.6	31.34	x 3.53
22	x 1.5	25	x 2	27.94	x 5.33	31.42	x 2.62
22	x 2	25	x 2.4	28	x 1.5	31.47	x 1.78
22	x 2.5	25	x 2.5	28	x 2	31.5	x 3
22	x 3	25	x 3	28	x 2.5	31.5	x 4.5
22	x 3.5	25	x 3.5	28	x 3	31.6	x 2.4
22	x 4	25	x 4	28	x 3.5	32	x 1
22	x 5	25	x 4.5	28	x 4	32	x 1.5
22	x 5.5	25	x 5	28	x 4.5	32	x 2
22	x 6	25	x 6	28	x 5	32	x 2.5
22	x 8	25	x 7	28	x 6	32	x 3
22.1	x 1.6	25	x 8	28	x 10	32	x 3.5
22.2	x 3	25	x 10	28.17	x 3.53	32	x 4
22.23	x 2.62	25	x 12	28.24	x 2.62	32	x 4.5
22.3	x 2.4	25.04	x 2.95	28.3	x 1.78	32	x 5
22.5	x 1.5	25.07	x 2.62	28.5	x 1	32	x 5.7
22.5	x 2	25.1	x 1.6	28.5	x 1.5	32	x 6
22.5	x 3	25.12	x 1.78	29	x 2	32	x 8
23	x 1	25.2	x 3	29	x 3	32	x 10
23	x 1.5	25.3	x 2.4	29	x 4	32.1	x 1.6
23	x 2	25.5	x 1	29	x 5	32.2	x 3
23	x 2.5	25.5	x 1.2	29	x 8	32.5	x 3
23	x 3	25.5	x 3	29.1	x 1.6	32.5	x 3.6
23	x 3.5	25.8	x 3.53	29.1	x 2.55	32.69	x 5.33
23	x 3.6	26	x 1	29.2	x 3	32.93	x 3.53
23	x 4	26	x 1.5	29.3	x 3.6	33	x 1.5
23	x 4.5	26	x 2	29.5	x 3	33	x 2
23	x 5	26	x 2.5	29.52	x 5.33	33	x 2.5
23	x 6	26	x 3	29.6	x 2.4	33	x 2.62
23	x 8	26	x 3.5	29.74	x 2.95	33	x 3
23	x 10	26	x 4	29.74	x 3.53	33	x 3.5
23.17	x 5.33	26	x 5	29.82	x 2.62	33	x 4
23.39	x 3.53	26	x 6	29.87	x 1.78	33	x 5
23.47	x 2.62	26	x 7	30	x 1	33	x 6.5
23.47	x 2.95	26.2	x 3	30	x 1.5	33	x 8
23.5	x 2.4	26.2	x 3.6	30	x 2	33.05	x 1.78
23.52	x 1.78	26.34	x 5.33	30	x 2.5	33.3	x 2.4
23.81	x 2.62	26.5	x 3	30	x 3	34	x 1
24	x 1	26.57	x 3.53	30	x 3.5	34	x 2
24	x 1.5	26.59	x 2.95	30	x 4	34	x 3
24	x 2	26.64	x 2.62	30	x 4.5	34	x 3.5
24	x 2.5	26.7	x 1.78	30	x 5	34	x 4
24	x 3	27	x 1.5	30	x 6	34	x 4.5
24	x 3.5	27	x 2	30	x 7	34	x 5
24	x 4	27	x 2.5	30	x 8	34	x 5.5
24	x 5	27	x 3	30	x 10	34	x 6
24	x 5.5	27	x 3.2	30	x 12	34	x 7
24	x 6	27	x 3.5	30.3	x 2.4	34	x 8
24	x 6.5	27	x 4	30.5	x 3	34	x 12
24	x 8	27	x 4.5	30.8	x 3.6	34.1	x 3.6
24	x 10	27	x 5	31	x 1.5	34.2	x 3
24.2	x 3	27	x 5.5	31	x 2	34.29	x 5.33
24.5	x 2.5	27	x 6	31	x 2.5	34.42	x 2.95
24.5	x 3	27	x 7	31	x 3	34.5	x 3

## O-ringen NBR 70

afmetingen		afmetingen		afmetingen		afmetingen	
di	x s	di	x s	di	x s	di	x s
34.52	x 3.53	38	x 3.5	41	x 8	44.5	x 3
34.59	x 2.62	38	x 4	41.2	x 5.7	44.6	x 2.4
34.6	x 2.4	38	x 4.5	41.28	x 3.53	45	x 1
34.65	x 1.78	38	x 5	41.4	x 5.33	45	x 1.5
35	x 1	38	x 6	41.5	x 3	45	x 2
35	x 1.5	38	x 6.5	41.6	x 2.4	45	x 2.5
35	x 2	38	x 7	42	x 1	45	x 3
35	x 2.5	38	x 8	42	x 1.5	45	x 3.5
35	x 3	38	x 9	42	x 2	45	x 4
35	x 3.2	38	x 10	42	x 2.5	45	x 4.5
35	x 3.5	38	x 12	42	x 3	45	x 5
35	x 4	39	x 1.5	42	x 3.5	45	x 5.5
35	x 4.5	39	x 2	42	x 4	45	x 6
35	x 5	39	x 2.5	42	x 4.5	45	x 7
35	x 5.7	39	x 3	42	x 5	45	x 8
35	x 6	39	x 3.5	42	x 6	45	x 9
35	x 7	39	x 4	42	x 7	45	x 10
35	x 8	39	x 5	42	x 8	45	x 12
35	x 10	39	x 5.5	42	x 9	45	x 15
35	x 15	39	x 6.5	42	x 10	45.2	x 3
35.1	x 1.6	39	x 10	42	x 13	45.3	x 5.7
35.6	x 3.6	39.2	x 3	42	x 14	45.69	x 2.62
36	x 2	39.2	x 5.7	42	x 16	46	x 2
36	x 2.5	39.34	x 2.62	42	x 20	46	x 2.5
36	x 3	39.45	x 1.78	42.2	x 3	46	x 3
36	x 3.5	39.5	x 3	42.5	x 3	46	x 3.5
36	x 4	39.6	x 2.4	42.52	x 2.62	46	x 4
36	x 5	39.69	x 3.53	42.86	x 3.53	46	x 4.5
36	x 7	40	x 1	43	x 1.5	46	x 5
36	x 8	40	x 1.5	43	x 2	46	x 6
36	x 9	40	x 2	43	x 2.5	46	x 7
36.1	x 3.53	40	x 2.5	43	x 3	46.04	x 3.53
36.17	x 2.62	40	x 3	43	x 3.5	47	x 1.5
36.2	x 3	40	x 3.5	43	x 4	47	x 2
36.27	x 1.78	40	x 4	43	x 4.5	47	x 2.5
36.5	x 3	40	x 4.5	43	x 5	47	x 3
37	x 2	40	x 5	43	x 5.5	47	x 3.5
37	x 2.5	40	x 5.5	43	x 6	47	x 4
37	x 3	40	x 6	43	x 8	47	x 5
37	x 3.5	40	x 7	43	x 10	47	x 5.33
37	x 4	40	x 7.5	43.4	x 3.6	47	x 5.5
37	x 5	40	x 8	43.69	x 3	47	x 6
37	x 5.5	40	x 10	43.82	x 5.33	47	x 10
37	x 6	40	x 11	44	x 1	47.2	x 5.7
37	x 8	40	x 12	44	x 2	47.22	x 3.53
37	x 10	40.65	x 5.33	44	x 2.5	47.29	x 2.62
37	x 15	40.86	x 3.53	44	x 3	47.35	x 1.78
37.1	x 1.6	40.94	x 2.62	44	x 3.5	47.6	x 2.4
37.2	x 3	41	x 1	44	x 4	47.63	x 3.53
37.3	x 3.6	41	x 1.78	44	x 4.5	48	x 1.5
37.47	x 5.33	41	x 2	44	x 5	48	x 2
37.5	x 3	41	x 2.5	44	x 5.5	48	x 2.5
37.6	x 2.4	41	x 3	44	x 6	48	x 3
37.69	x 3.53	41	x 3.5	44	x 6.5	48	x 3.5
37.77	x 2.62	41	x 4	44.04	x 3.53	48	x 4
37.82	x 1.78	41	x 4.5	44.12	x 2.62	48	x 4.5
38	x 1.5	41	x 5	44.17	x 1.78	48	x 5
38	x 2	41	x 6	44.2	x 3	48	x 5.5
38	x 2.5	41	x 6.5	44.2	x 5.7	48	x 6
38	x 3	41	x 7.5	44.45	x 3.53	48	x 6.5



## O-ringen NBR 70

afmetingen		afmetingen		afmetingen		afmetingen	
di	x s	di	x s	di	x s	di	x s
48	x 7	52	x 5	56	x 4	60	x 7
48	x 8	52	x 6	56	x 4.5	60	x 8
48	x 9	52	x 9	56	x 5	60	x 9
48	x 10	52	x 10	56	x 6	60	x 10
48.9	x 2.62	52.07	x 2.62	56.2	x 3	60	x 11
49	x 1	52.3	x 5.7	56.52	x 5.33	60	x 13
49	x 2.5	52.39	x 3.53	56.74	x 3.53	60	x 15
49	x 3	53	x 1.5	56.82	x 2.62	60	x 18
49	x 3.5	53	x 2	56.87	x 1.78	60.05	x 1.78
49	x 4	53	x 2.5	57	x 2	60.32	x 3.53
49	x 6	53	x 3	57	x 2.5	61	x 2
49	x 7	53	x 3.5	57	x 3	61	x 3.5
49.2	x 3.53	53	x 4	57	x 3.5	61	x 4
49.2	x 5.7	53	x 4.5	57	x 4	61	x 4.5
49.5	x 3	53	x 5	57	x 4.5	61	x 5
49.6	x 2.4	53	x 6	57	x 5	61.6	x 2.4
50	x 1	53	x 7	57	x 6	61.6	x 2.62
50	x 1.5	53	x 10	57	x 6.5	61.9	x 3.53
50	x 2	53.09	x 3	57	x 7	62	x 1.5
50	x 2.5	53.34	x 5.33	57	x 8	62	x 2
50	x 3	53.57	x 3.53	57	x 10	62	x 2.5
50	x 3.5	53.64	x 2.62	57.15	x 3.53	62	x 3
50	x 4	53.7	x 1.78	57.2	x 5.7	62	x 3.5
50	x 4.5	53.98	x 3.53	57.6	x 2.4	62	x 4
50	x 5	54	x 2	58	x 1	62	x 5
50	x 5.5	54	x 2.5	58	x 2	62	x 5.5
50	x 6	54	x 3	58	x 3	62	x 5.7
50	x 6.5	54	x 3.5	58	x 3.5	62	x 6
50	x 7	54	x 4	58	x 4	62	x 6.5
50	x 8	54	x 5	58	x 5	62	x 7
50	x 9	54	x 6	58	x 5.5	62	x 10
50	x 10	54	x 8	58	x 6	62	x 11
50	x 10.5	54.2	x 3	58	x 7	62	x 12
50	x 11	54.2	x 5.7	58	x 8	62.3	x 5.7
50	x 12	54.3	x 5.7	58	x 10	62.87	x 5.33
50	x 15	54.4	x 5.33	58.42	x 2.62	63	x 1.5
50	x 16	54.5	x 3	58.74	x 3.53	63	x 2
50.16	x 5.33	54.6	x 2.4	59	x 2.5	63	x 2.5
50.39	x 3.53	55	x 1	59	x 3	63	x 3
50.47	x 2.62	55	x 2	59	x 3.5	63	x 3.5
50.5	x 3	55	x 2.5	59	x 4	63	x 4
50.52	x 1.78	55	x 3	59	x 5	63	x 4.5
50.8	x 3.53	55	x 3.5	59.2	x 5.7	63	x 5
51	x 2	55	x 4	59.3	x 5.7	63	x 5.5
51	x 2.5	55	x 4.5	59.5	x 3	63	x 6
51	x 3	55	x 5	59.6	x 2.4	63.09	x 3.53
51	x 3.5	55	x 6	59.69	x 5.33	63.17	x 2.62
51	x 4	55	x 6.5	59.92	x 3.53	63.22	x 1.78
51	x 4.5	55	x 7	60	x 1	63.5	x 3.53
51	x 5	55	x 7.5	60	x 1.2	64	x 3
51	x 5.5	55	x 8	60	x 1.5	64	x 3.5
51	x 6	55	x 10	60	x 2	64	x 4
51.2	x 5.7	55.2	x 3	60	x 2.5	64	x 5
51.6	x 2.4	55.25	x 2.62	60	x 2.62	64	x 5.7
52	x 1.5	55.3	x 5.7	60	x 3	64	x 6
52	x 2	55.56	x 3.53	60	x 3.5	64	x 8
52	x 2.5	56	x 2	60	x 4	64.2	x 5.7
52	x 3	56	x 2.5	60	x 4.5	64.3	x 5.7
52	x 3.5	56	x 3	60	x 5	64.5	x 3
52	x 4	56	x 3.5	60	x 6	64.6	x 2.4

## O-ringen NBR 70

afmetingen		afmetingen		afmetingen		afmetingen	
di	x s	di	x s	di	x s	di	x s
64.77	x 2.62	69	x 1.5	73	x 2	77.2	x 5.7
65	x 1.5	69	x 3	73	x 2.5	77.5	x 2.62
65	x 2	69	x 3.5	73	x 3	78	x 1.5
65	x 2.5	69	x 4	73	x 3.5	78	x 2
65	x 3	69	x 4.5	73	x 4	78	x 2.5
65	x 3.5	69	x 5	73	x 4.5	78	x 3
65	x 4	69	x 5.7	73	x 5	78	x 3.5
65	x 4.5	69.2	x 5.7	73.03	x 3.53	78	x 4
65	x 5	69.22	x 5.33	74	x 1	78	x 4.5
65	x 5.5	69.3	x 5.7	74	x 1.5	78	x 5
65	x 6	69.44	x 3.53	74	x 2	78	x 6
65	x 7	69.5	x 3	74	x 2.5	78	x 10
65	x 7.5	69.52	x 2.62	74	x 3	78.74	x 5.33
65	x 8	69.57	x 1.78	74	x 3.5	78.97	x 3.53
65	x 9	69.6	x 2.4	74	x 4	79	x 1.78
65	x 10	69.85	x 3.53	74	x 4.5	79	x 5.7
65	x 10.5	70	x 1.5	74	x 5	79.2	x 5.7
65	x 12	70	x 2	74	x 5.7	79.3	x 5.7
65	x 13	70	x 2.5	74	x 6	79.5	x 3
65.09	x 3.53	70	x 3	74	x 7.5	79.73	x 5.33
66	x 1.5	70	x 3.5	74	x 8	80	x 1.5
66	x 2	70	x 4	74	x 10	80	x 2
66	x 3	70	x 4.5	74.2	x 5.7	80	x 2.5
66	x 3.5	70	x 5	74.3	x 2.62	80	x 3
66	x 4	70	x 5.5	74.3	x 5.7	80	x 3.5
66	x 5	70	x 6	74.5	x 3	80	x 4
66	x 6	70	x 6.5	74.61	x 3.53	80	x 4.5
66	x 6.5	70	x 7	74.63	x 5.33	80	x 5
66	x 7.5	70	x 7.5	75	x 2	80	x 5.5
66	x 8	70	x 8	75	x 2.5	80	x 6
66.04	x 5.33	70	x 10	75	x 3	80	x 6.5
66.27	x 3.53	70	x 11	75	x 3.5	80	x 7
66.34	x 2.62	70	x 15	75	x 4	80	x 8
66.4	x 1.78	70	x 20	75	x 4.5	80	x 10
66.68	x 3.53	71	x 2	75	x 5	80	x 12
67	x 1.5	71	x 3	75	x 5.5	80	x 15
67	x 2	71	x 3.5	75	x 6	80.6	x 2.62
67	x 2.5	71	x 4	75	x 7	81	x 2
67	x 3	71.12	x 2.62	75	x 7.5	81	x 2.5
67	x 3.5	71.44	x 3.53	75	x 8	81	x 3
67	x 4	71.85	x 1.78	75	x 10	81	x 3.5
67	x 5	72	x 1.5	75.57	x 5.33	81	x 4
67	x 6	72	x 2	75.79	x 3.53	81	x 4.5
67	x 8	72	x 2.5	75.87	x 2.62	81	x 5
67.2	x 5.7	72	x 3	75.92	x 1.78	81.2	x 5.7
67.6	x 2.4	72	x 3.5	76	x 1.5	81.92	x 5.33
67.95	x 2.62	72	x 4	76	x 2	82	x 2
68	x 2	72	x 5	76	x 2.5	82	x 3
68	x 2.5	72	x 5.5	76	x 3	82	x 3.5
68	x 3	72	x 7	76	x 3.5	82	x 4
68	x 3.5	72	x 8	76	x 4	82	x 4.5
68	x 4	72	x 9	76	x 4.5	82	x 5
68	x 4.5	72	x 10	76	x 5	82	x 5.5
68	x 5	72	x 11	76	x 6	82	x 6.5
68	x 5.5	72	x 12	76	x 8	82	x 7
68	x 6	72.2	x 5.7	76	x 10	82	x 7.5
68	x 7	72.39	x 5.33	77	x 3	82	x 8
68	x 10	72.62	x 3.53	77	x 3.5	82	x 10
68	x 15	72.69	x 2.62	77	x 4	82.14	x 3.53
68.26	x 3.53	72.75	x 1.78	77	x 5	82.2	x 5.7

## O-ringen NBR 70

afmetingen		afmetingen		afmetingen		afmetingen	
di	x s	di	x s	di	x s	di	x s
82.22	x 2.62	88	x 5	94	x 8	102	x 3
82.27	x 1.78	88	x 5.5	94.2	x 5.7	102	x 3.5
83	x 2	88	x 6	94.5	x 3	102	x 4
83	x 2.5	88	x 7.5	94.62	x 5.33	102	x 5
83	x 3	88	x 8	94.84	x 3.53	103	x 1.5
83	x 3.5	88	x 12	94.92	x 2.62	103	x 3
83	x 4	88	x 15	94.97	x 1.78	103	x 3.5
83	x 4.5	88.27	x 5.33	95	x 1.5	103	x 5
83	x 5	88.49	x 3.53	95	x 2	103	x 6
83	x 5.5	88.57	x 2.62	95	x 2.5	104	x 2.5
83.8	x 2.62	88.62	x 1.78	95	x 3	104	x 3
84	x 2	89	x 3.5	95	x 3.5	104	x 3.5
84	x 2.5	89.3	x 5.7	95	x 4	104	x 4
84	x 3	89.5	x 3	95	x 4.5	104	x 5
84	x 3.5	89.69	x 5.33	95	x 5	104	x 5.7
84	x 4	90	x 1	95	x 5.5	104	x 6
84	x 4.5	90	x 2	95	x 6	104	x 8
84	x 5	90	x 2.5	95	x 7	104.14	x 5.33
84	x 5.7	90	x 3	95	x 7.5	104.3	x 5.7
84	x 6	90	x 3.5	95	x 8	104.37	x 3.53
84.1	x 5.7	90	x 4	95	x 10	104.4	x 1.78
84.3	x 5.7	90	x 4.5	96	x 2.5	105	x 1.5
84.5	x 3	90	x 5	96	x 3	105	x 2
85	x 2	90	x 5.5	96	x 4	105	x 2.5
85	x 2.5	90	x 6	97.79	x 5.33	105	x 3
85	x 3	90	x 7	98	x 3	105	x 3.5
85	x 3.5	90	x 7.5	98	x 3.5	105	x 4
85	x 4	90	x 8	98	x 4	105	x 4.5
85	x 4.5	90	x 8.5	98	x 4.5	105	x 5
85	x 5	90	x 10	98	x 5	105	x 5.5
85	x 5.5	90	x 11	98	x 6	105	x 6
85	x 6	90	x 14	98.02	x 3.53	105	x 7
85	x 6.5	90	x 15	98.05	x 1.78	105	x 7.5
85	x 7	91.44	x 5.33	99	x 5	105	x 9.5
85	x 8	91.67	x 3.53	99	x 6	105	x 10
85	x 10	91.7	x 1.78	99.1	x 5.7	107	x 3.5
85	x 12	92	x 1.5	99.3	x 5.7	107	x 4
85	x 16	92	x 3	99.5	x 3	107	x 5
85.09	x 5.33	92	x 3.5	100	x 1	107.32	x 5.33
85.32	x 3.53	92	x 4	100	x 1.5	107.54	x 3.53
85.34	x 1.78	92	x 4.5	100	x 2	107.62	x 2.62
86	x 2	92	x 5	100	x 2.5	107.67	x 1.78
86	x 2.5	92	x 5.5	100	x 3	108	x 3
86	x 3	92	x 6	100	x 3.5	108	x 3.5
86	x 3.5	92	x 7.5	100	x 4	108	x 4
86	x 4	92	x 10	100	x 4.5	108	x 5
86	x 4.5	92.2	x 5.7	100	x 5	108	x 6
86	x 5	93	x 3	100	x 5.33	108	x 8
87	x 2	93	x 4	100	x 5.5	108	x 10
87	x 3	93	x 5	100	x 6	109.1	x 5.7
87	x 4	93	x 6	100	x 7	109.3	x 5.7
87	x 4.5	93	x 6.5	100	x 7.5	109.5	x 3
87	x 5	94	x 1	100	x 8	109.5	x 3.53
87	x 7	94	x 1.5	100	x 10	109.54	x 5.33
87.2	x 5.7	94	x 2.5	100	x 12	110	x 2
87.5	x 4	94	x 3	100	x 16	110	x 3
88	x 1.5	94	x 4	101	x 5.33	110	x 3.5
88	x 3	94	x 5	101.19	x 3.53	110	x 4
88	x 3.5	94	x 5.7	101.27	x 2.62	110	x 4.5
88	x 4	94	x 7	101.32	x 1.78	110	x 5

## O-ringen NBR 70

afmetingen		afmetingen		afmetingen		afmetingen	
di	x s	di	x s	di	x s	di	x s
110	x 5.5	118	x 2	127	x 4	136.53	x 5.33
110	x 6	118	x 3	127	x 5	137	x 4
110	x 6.5	118	x 3.5	127	x 5.33	138	x 3
110	x 7	118	x 4	128	x 2	138	x 4
110	x 7.5	118	x 4.5	128	x 2.5	138	x 5
110	x 8	118	x 5	128	x 3	138	x 6
110	x 10	118	x 6	128	x 4	138.94	x 1.78
110	x 12	119	x 5.7	128	x 5	139.07	x 7
110	x 20	119.5	x 3	128	x 6	139.29	x 3.53
110.49	x 5.33	120	x 1.5	129.3	x 5.7	139.3	x 5.7
110.72	x 3.53	120	x 2	129.4	x 1.78	139.37	x 2.62
110.74	x 1.78	120	x 2.5	129.5	x 3	139.5	x 3
112	x 1.5	120	x 3	129.54	x 5.33	139.7	x 5.33
112	x 2.5	120	x 3.5	129.54	x 7	140	x 2
112	x 3	120	x 4	129.77	x 3.53	140	x 2.5
112	x 3.5	120	x 4.5	130	x 1.5	140	x 3
112	x 4	120	x 5	130	x 2	140	x 3.5
112	x 5	120	x 6	130	x 2.5	140	x 4
112	x 6	120	x 6.5	130	x 3	140	x 4.5
112	x 8	120	x 7	130	x 3.5	140	x 5
113	x 4	120	x 8.5	130	x 4	140	x 6
113.67	x 5.33	120	x 10	130	x 4.5	140	x 7.5
113.67	x 7	120.02	x 5.33	130	x 5	140	x 8
113.89	x 3.53	120.02	x 7	130	x 5.5	140	x 12
113.97	x 2.62	120.24	x 3.53	130	x 6	140	x 15
114	x 3.5	120.32	x 2.62	130	x 7.5	142	x 3
114	x 4	120.37	x 1.78	130	x 8	142	x 4
114	x 5	120.65	x 5.33	130	x 10	142	x 5
114	x 5.5	122	x 2	130	x 12	142	x 6
114	x 5.7	122	x 3	130.18	x 5.33	142.11	x 1.78
114	x 6	122	x 4	131.44	x 1.78	142.24	x 7
114.02	x 1.78	122	x 4.5	132	x 2	142.47	x 3.53
114.3	x 5.7	122	x 5	132	x 3	142.88	x 5.33
114.5	x 3	122	x 5.5	132	x 4	143	x 4
114.7	x 7	122	x 6	132	x 5	144	x 4
115	x 2	122	x 8	132	x 6	144.1	x 8.4
115	x 2.5	123.19	x 5.33	132	x 8	144.3	x 5.7
115	x 3	123.19	x 7	132.72	x 5.33	144.5	x 3
115	x 3.5	123.42	x 3.53	132.72	x 7	145	x 1.5
115	x 4	123.44	x 1.78	132.94	x 3.53	145	x 2.5
115	x 4.5	123.83	x 5.33	133.02	x 2.62	145	x 3
115	x 5	124	x 5.7	133.07	x 1.78	145	x 3.5
115	x 5.5	124.5	x 3	133.35	x 5.33	145	x 4
115	x 6	124.6	x 7	134	x 4	145	x 5
115	x 7.5	125	x 2	134.3	x 5.7	145	x 6
115	x 8.5	125	x 2.5	134.5	x 3	145	x 7
116	x 2.5	125	x 3	134.5	x 4.5	145	x 7.5
116	x 3	125	x 3.5	134.50	x 7	145	x 8
116	x 4	125	x 4	135	x 2.5	145	x 10
116	x 5	125	x 5	135	x 3	145.29	x 1.78
116.84	x 5.33	125	x 6	135	x 3.5	145.42	x 5.33
116.84	x 7	125	x 7.5	135	x 4	145.42	x 7
117	x 2.5	125	x 8	135	x 5	145.64	x 3.53
117	x 3	125	x 10	135	x 6	145.72	x 2.62
117	x 3.5	126.36	x 5.33	135	x 7.5	146.05	x 5.33
117	x 4	126.36	x 7	135	x 10	147	x 3
117.07	x 3.53	126.59	x 3.53	135.76	x 1.78	148	x 4
117.1	x 1.78	126.67	x 2.62	135.89	x 5.33	148	x 5
117.48	x 5.33	126.72	x 1.78	135.89	x 7	148	x 6
118	x 1	127	x 3.5	136.12	x 3.53	148	x 8

## O-ringen NBR 70

afmetingen		afmetingen		afmetingen		afmetingen	
di	x s	di	x s	di	x s	di	x s
148	x 10	161.3	x 5.33	175	x 4	193.7	x 7
148.46	x 1.78	161.9	x 7	175	x 5	194.1	x 8.4
148.59	x 5.33	162	x 4	175	x 6	194.3	x 5.7
148.59	x 7	164.1	x 8.4	175	x 7	194.5	x 3
148.82	x 3.53	164.3	x 5.7	175	x 8	195	x 2.5
149.1	x 8.4	164.34	x 1.78	177.17	x 5.33	195	x 3
149.23	x 5.33	164.47	x 5.33	177.17	x 7	195	x 3.5
149.3	x 5.7	164.47	x 7	177.39	x 3.53	195	x 4
149.5	x 3	164.5	x 3	177.47	x 2.62	195	x 5
150	x 2	164.69	x 3.53	179.1	x 8.4	195	x 6
150	x 2.5	164.72	x 2.62	179.3	x 5.7	195	x 7
150	x 3	165	x 2	179.5	x 3	195	x 8
150	x 3.5	165	x 2.5	180	x 3	195	x 10
150	x 4	165	x 3	180	x 3.5	196.22	x 5.33
150	x 4.5	165	x 3.5	180	x 4	196.22	x 7
150	x 5	165	x 4	180	x 4.5	196.44	x 3.53
150	x 6	165	x 4.5	180	x 5	196.52	x 2.62
150	x 7	165	x 5	180	x 6	199.1	x 8.4
150	x 8	165	x 6	180	x 7.5	199.3	x 5.7
150	x 15	165	x 6.5	180	x 8	199.5	x 3
151.64	x 1.78	165	x 7	180	x 10	200	x 2
151.77	x 5.33	165	x 8	181	x 7	200	x 3
151.77	x 7	165	x 10	183.52	x 5.33	200	x 4
151.99	x 3.53	165	x 16	183.52	x 7	200	x 5
152.07	x 2.62	165	x 20	183.75	x 3.53	200	x 6
154.1	x 8.4	166.7	x 7	183.82	x 2.62	200	x 6.5
154.3	x 5.7	167	x 4	184.1	x 8.4	200	x 7
154.5	x 3	167.51	x 1.78	184.3	x 5.7	200	x 8
154.81	x 1.78	167.7	x 5.33	184.5	x 3	200	x 12
155	x 2.5	168	x 4	185	x 2	202.57	
155	x 3	168.3	x 7	185	x 3	202.57	
155	x 4	169.1	x 8.4	185	x 3.5	202.79	
155	x 4.5	169.3	x 5.7	185	x 4	202.87	
155	x 5	169.5	x 3	185	x 4.5	204.1	x 8.4
155	x 6	170	x 2	185	x 5	204.5	x 3
155	x 8	170	x 2.5	185	x 6	205	x 2
155	x 15	170	x 3	185	x 8	205	x 3
155.6	x 7	170	x 3.5	185	x 10	205	x 4
156	x 4	170	x 4	187	x 4	205	x 5
158	x 1.78	170	x 5	187.3	x 7	205	x 6
158	x 5	170	x 6	188	x 1.5	205	x 8
158.12	x 5.33	170	x 7	188	x 2	206	x 7
158.12	x 7	170	x 7.5	188	x 3	208	x 4
158.34	x 3.53	170	x 8	188	x 4	208	x 6
158.42	x 2.62	170	x 8.5	189.1	x 8.4	208.92	
159.1	x 8.4	170	x 10	189.3	x 5.7	208.92	
159.3	x 5.7	170.69	x 1.78	189.5	x 3	209.1	x 8.4
159.5	x 3	170.82	x 5.33	189.87	x 5.33	209.15	
159.5	x 7	170.82	x 7	189.87	x 7	209.22	
160	x 2	171.04	x 3.53	190	x 2	209.3	x 5.7
160	x 2.5	171.12	x 2.62	190	x 3	209.5	x 3
160	x 3	173.87	x 1.78	190	x 3.5	210	x 2
160	x 3.5	174	x 5.33	190	x 4	210	x 3
160	x 4	174.1	x 8.4	190	x 5	210	x 3.5
160	x 4.5	174.3	x 5.7	190	x 6	210	x 4
160	x 5	174.5	x 3	190	x 7	210	x 5
160	x 6	174.6	x 7	190	x 8	210	x 6
160	x 8	175	x 2	190	x 10	210	x 7
160	x 10	175	x 2.5	190.09	x 3.53	210	x 8
161.16	x 1.78	175	x 3	190.17	x 2.62	210	x 10

## O-ringen NBR 70

afmetingen		afmetingen		afmetingen		afmetingen	
di	x s	di	x s	di	x s	di	x s
212	x 7	235	x 6	260	x 10	290	x 7
215	x 3	235	x 7	265	x 3	290	x 8
215	x 4	235	x 8	265	x 4	290	x 10
215	x 4.5	235	x 10	265	x 5	291.47	x 5.33
215	x 5	236	x 7	265	x 6	291.47	x 7
215	x 6	239.1	x 8.4	265	x 6.5	291.69	x 3.53
215	x 7	239.3	x 5.7	265	x 7	295	x 4
215	x 8	239.5	x 3	265	x 8	295	x 5
215	x 10	240	x 2.5	265	x 9	295	x 6
215.27	x 5.33	240	x 3	265	x 10	295	x 7
215.27	x 7	240	x 3.5	266.07	x 5.33	295	x 10
215.49	x 3.53	240	x 4	266.07	x 7	297.8	x 7
215.57	x 2.62	240	x 5	266.29	x 3.53	299.3	x 5.7
218	x 7	240	x 6	268	x 4	300	x 2
219.1	x 8.4	240	x 7	269.3	x 5.7	300	x 3
219.3	x 5.7	240	x 8	270	x 2.5	300	x 3.5
219.5	x 3	240	x 12	270	x 3	300	x 4
220	x 2	240.67	x 5.33	270	x 4	300	x 5
220	x 3	240.67	x 7	270	x 5	300	x 6
220	x 4	240.89	x 3.53	270	x 6	300	x 6.5
220	x 5	240.97	x 2.62	270	x 7	300	x 7
220	x 6	244	x 6	270	x 8	300	x 7.5
220	x 7	245	x 3	270	x 10	300	x 8
220	x 8	245	x 5	272.4	x 7	300	x 10
220	x 10	247	x 7	275	x 2	304.17	x 7
221.62	x 7	247.02	x 5.33	275	x 2.5	304.17	x 7
221.62	x 5.33	247.25	x 3.53	275	x 3	304.39	x 3.53
221.84	x 3.53	247.32	x 2.62	275	x 3.5	305	x 3
221.92	x 2.62	248	x 5	275	x 4	305	x 3.5
224	x 7	249.1	x 8.4	275	x 5	305	x 4
225	x 3	249.3	x 5.7	275	x 7.5	305	x 5
225	x 4	249.5	x 3	275	x 8	305	x 6
225	x 4.5	250	x 3	278	x 6	310	x 3
225	x 5	250	x 3.5	278	x 8	310	x 4
225	x 6	250	x 4	278.77	x 5.33	310	x 5
225	x 8	250	x 4.5	278.77	x 7	310	x 6
227.97	x 5.33	250	x 5	278.99	x 3.53	310	x 8
227.97	x 7	250	x 6	279.3	x 5.7	310	x 10
228	x 4	250	x 7	280	x 2.5	310	x 12
228.19	x 3.53	250	x 8	280	x 3	310.05	x 7
228.27	x 2.62	250	x 10	280	x 3.5	315	x 2.5
229.1	x 8.4	253.37	x 5.33	280	x 4	315	x 3
229.3	x 5.7	253.37	x 7	280	x 5	315	x 4
229.5	x 3	253.59	x 3.53	280	x 6	315	x 4.5
230	x 2	255	x 2	280	x 7	315	x 5
230	x 3	255	x 3	280	x 8	315	x 6
230	x 4	255	x 4	280	x 9	315	x 7
230	x 5	255	x 5	280	x 10	315	x 10
230	x 6	255	x 7	285	x 3	316.87	x 7
230	x 7	258	x 5	285	x 3.5	319.3	x 5.7
230	x 8	259.3	x 5.7	285	x 4	320	x 2.5
234.1	x 8.4	259.7	x 7	285	x 5	320	x 3
234.32	x 5.33	260	x 2.5	285	x 6	320	x 4
234.32	x 7	260	x 3	285.1	x 7	320	x 5
234.55	x 3.53	260	x 4	289.3	x 5.7	320	x 5.5
234.62	x 2.62	260	x 5	290	x 2	320	x 6
235	x 3	260	x 6	290	x 2.5	320	x 6.5
235	x 3.5	260	x 6.5	290	x 3	320	x 7
235	x 4	260	x 7	290	x 5	320	x 8
235	x 5	260	x 8	290	x 6	320	x 10

## O-ringen NBR 70

afmetingen		afmetingen		afmetingen		afmetingen	
di	x s	di	x s	di	x s	di	x s
323.2	x 7	370	x 6	430	x 10	500	x 10
325	x 5	370	x 7	430.66	x 3.53	506.86	x 5.33
325	x 6	370	x 10	430.66	x 5.33	506.86	x 7
325	x 7	370	x 12	430.66	x 7	510	x 5
325.9	x 7	375	x 5	435	x 8	510	x 6
329.3	x 5.7	375	x 6	437	x 7	515	x 7
329.57	x 5.33	375	x 7	439.3	x 5.7	520	x 5
329.57	x 7	375	x 10	440	x 3	520	x 10
329.79	x 3.53	379.3	x 5.7	440	x 4	525	x 8
330	x 4	380	x 3	440	x 8	530	x 4
330	x 5	380	x 4	443.35	x 7	530	x 5
330	x 6	380	x 5	445	x 5	530	x 6
330	x 8	380	x 6	450	x 3	530	x 7
330	x 10	380	x 7	450	x 4	530	x 8
335	x 4	380	x 8	450	x 5	530	x 10
335	x 5	380	x 10	450	x 6	532.26	x 5.33
335	x 6	380.37	x 5.33	450	x 7	532.26	x 7
339.3	x 5.7	380.37	x 7	450	x 8	540	x 3
340	x 3.5	380.59	x 3.53	450	x 10	540	x 4
340	x 4	385	x 5	455	x 5	540	x 5
340	x 5	385	x 6	455	x 8	540	x 6
340	x 6	387	x 7	456.06	x 3.53	540	x 8
340	x 7	390	x 3	456.06	x 7	540	x 10
340	x 10	390	x 4	456.06	x 5.33	545.47	x 7
340	x 12	390	x 5	457.2	x 7	550	x 5
342.27	x 7	390	x 6	459.3	x 5.7	550	x 6
342.49	x 3.53	393.1	x 7	460	x 4	550	x 8
345	x 2	395	x 5	460	x 5	550	x 10
345	x 2.5	395	x 6	460	x 8	557.66	x 5.33
345	x 5	395	x 10	462	x 7	557.66	x 7
345	x 6	399.3	x 5.7	465	x 5	560	x 4
345	x 7	400	x 2	465	x 7	560	x 5
350	x 2	400	x 3	468.76	x 7	560	x 6
350	x 2.5	400	x 4	470	x 3.5	560	x 7
350	x 4	400	x 5	470	x 4	570	x 6
350	x 5	400	x 6	470	x 6	575	x 6
350	x 6	400	x 7	470	x 7	580	x 6
350	x 8	400	x 8	470	x 8	580	x 7
350	x 10	400	x 10	470	x 10	580	x 8
350	x 12	405.26	x 3.53	475	x 4	580	x 10
354.97	x 5.33	405.26	x 5.33	475	x 5	580	x 12
354.97	x 7	405.26	x 7	475	x 7	582.68	x 5.33
355	x 4	410	x 4	479.3	x 5.7	582.68	x 7
355	x 5	410	x 5	480	x 4	590	x 5
355	x 6	410	x 8	480	x 5	596.27	x 7
355	x 8	412	x 7	480	x 6	600	x 4
355.19	x 3.53	415	x 5	480	x 8	600	x 5
359.3	x 5.7	415	x 6	481.46	x 5.33	600	x 7
360	x 4	417.96	x 7	481.46	x 7	600	x 8
360	x 5	419.3	x 5.7	485	x 5	600	x 10
360	x 6	420	x 2.5	487	x 7	608.08	x 5.33
360	x 8	420	x 4	490	x 5	608.08	x 7
360	x 10	420	x 5	490	x 8	615	x 7
360	x 15	420	x 10	494.16	x 7	630	x 7
365	x 4	425	x 4	495	x 3	633.48	x 5.33
365	x 5	425	x 5	499.3	x 5.7	633.48	x 7
365	x 6	425	x 7	500	x 5	647.07	x 7
367.67	x 7	425	x 8	500	x 6	650	x 7
370	x 4	430	x 4	500	x 7	658.88	x 5.33
370	x 5	430	x 6	500	x 8	658.88	x 7

## O-ringen FPM - Viton®

afmetingen		afmetingen		afmetingen		afmetingen	
di	x s	di	x s	di	x s	di	x s
1.5	x 1	7	x 5	11.6	x 2.4	16	x 2.5
1.78	x 1.78	7	x 6	11.91	x 2.62	16	x 3
2	x 1	7.1	x 1.6	12	x 1	16	x 3.5
2	x 1.5	7.3	x 2.4	12	x 1.5	16	x 4
2.4	x 1.9	7.5	x 1.5	12	x 2	16.1	x 1.6
2.5	x 1	7.5	x 2	12	x 2.5	16.3	x 2.4
2.57	x 1.78	7.52	x 3.53	12	x 3	16.82	x 5.33
2.84	x 2.62	7.59	x 2.62	12	x 3.5	17	x 1
2.9	x 1.78	7.6	x 2.4	12	x 4	17	x 1.5
3	x 1	7.65	x 1.78	12	x 5	17	x 2
3	x 1.5	7.94	x 1.78	12.07	x 5.33	17	x 2.5
3	x 2	8	x 1	12.1	x 1.6	17	x 3
3	x 3	8	x 1.5	12.29	x 3.53	17	x 4
3.1	x 1.6	8	x 2	12.3	x 2.4	17	x 5
3.17	x 1.78	8	x 2.5	12.37	x 2.62	17.04	x 3.53
3.3	x 2.4	8	x 3	12.42	x 1.78	17.1	x 1.6
3.4	x 1.9	8	x 4	13	x 1	17.12	x 2.62
3.63	x 2.62	8	x 5	13	x 1.5	17.17	x 1.78
3.68	x 1.78	8.1	x 1.6	13	x 2	17.3	x 2.4
4	x 1	8.3	x 2.4	13	x 2.5	17.6	x 2.4
4	x 1.5	8.73	x 1.78	13	x 3	17.86	x 2.62
4	x 2	9	x 1	13	x 4	18	x 1
4	x 2.5	9	x 1.5	13	x 6	18	x 1.5
4.1	x 1.6	9	x 2	13.1	x 1.6	18	x 2
4.2	x 1.9	9	x 2.5	13.1	x 2.62	18	x 2.5
4.3	x 2.4	9	x 3	13.3	x 2.4	18	x 3
4.42	x 2.62	9	x 6	13.64	x 5.33	18	x 3.5
4.47	x 1.78	9.1	x 1.6	13.87	x 3.53	18	x 4
4.6	x 2.4	9.12	x 3.53	13.94	x 2.62	18	x 5
4.7	x 1.42	9.13	x 2.62	14	x 1	18.1	x 1.6
4.7	x 1.6	9.19	x 2.62	14	x 1.5	18.3	x 2.4
5	x 1	9.25	x 1.78	14	x 1.78	18.42	x 5.33
5	x 1.5	9.3	x 2.4	14	x 2	18.5	x 2.5
5	x 2	9.5	x 2	14	x 2.5	18.64	x 3.53
5	x 2.5	9.52	x 1.78	14	x 3	18.72	x 2.62
5	x 3	9.6	x 2.4	14	x 4	18.77	x 1.78
5.1	x 1.6	9.92	x 2.62	14	x 5	19	x 1
5.23	x 2.62	10	x 1	14.1	x 1.6	19	x 1.5
5.28	x 1.78	10	x 1.5	14.3	x 2.4	19	x 2
5.3	x 2.4	10	x 2	15	x 1	19	x 2.5
5.94	x 3.53	10	x 2.5	15	x 1.5	19	x 3
6	x 1	10	x 3	15	x 2	19	x 3.5
6	x 1.5	10	x 3.5	15	x 2.5	19	x 4
6	x 2	10	x 4	15	x 3	19	x 5
6	x 2.5	10	x 5	15	x 3.5	19.1	x 1.6
6	x 3	10.1	x 1.6	15	x 4	19.2	x 3
6	x 4	10.3	x 2.4	15	x 5	19.3	x 2.4
6.02	x 2.62	10.46	x 5.33	15	x 6	19.5	x 3
6.07	x 1.78	10.69	x 3.53	15.08	x 2.62	19.99	x 5.33
6.1	x 1.6	10.78	x 2.62	15.1	x 1.6	20	x 1
6.3	x 2.4	10.82	x 1.78	15.24	x 5.33	20	x 1.5
6.35	x 1.78	11	x 1	15.3	x 2.4	20	x 1
6.6	x 2.4	11	x 1.5	15.47	x 3.53	20	x 2
6.75	x 1.78	11	x 2	15.54	x 2.62	20	x 2.5
7	x 1	11	x 2.5	15.6	x 1.78	20	x 3
7	x 1.5	11	x 3	15.6	x 2.4	20	x 3.5
7	x 2	11	x 3.5	15.88	x 2.62	20	x 4
7	x 2.5	11.1	x 1.6	16	x 1	20	x 5
7	x 3	11.11	x 1.78	16	x 1.5	20	x 6
7	x 4	11.3	x 2.4	16	x 2	20.22	x 3.53



## O-ringen FPM - Viton®

afmetingen		afmetingen		afmetingen		afmetingen	
di	x s	di	x s	di	x s	di	x s
20.29	x 2.62	25	x 3	31	x 1.5	37	x 3.5
20.3	x 2.4	25	x 3.5	31	x 2	37	x 4
20.35	x 1.78	25	x 4	31	x 2.5	37	x 5
21	x 1.5	25	x 4.5	31	x 3	37.1	x 1.6
21	x 2	25	x 5	31	x 4	37.47	x 5.33
21	x 2.5	25	x 6	31.12	x 5.33	37.6	x 2.4
21	x 3	25.07	x 2.62	31.34	x 3.53	37.69	x 3.53
21	x 3.5	25.1	x 1.6	31.42	x 2.62	37.77	x 2.62
21	x 4	25.12	x 1.78	31.47	x 1.78	37.82	x 1.78
21	x 5	25.8	x 3.53	32	x 1.5	38	x 1.5
21.3	x 2.4	26	x 1.5	32	x 2	38	x 2
21.5	x 2.4	26	x 2	32	x 2.5	38	x 2.5
21.59	x 5.33	26	x 2.5	32	x 3.5	38	x 3
21.82	x 3.53	26	x 4	32	x 4	38	x 3.5
21.89	x 2.62	26	x 5	32	x 5	38	x 4
21.95	x 1.78	26	x 6	32.1	x 1.6	38	x 5
22	x 1	26.2	x 3	32.3	x 3	38	x 6
22	x 1.5	26.34	x 5.33	32.69	x 5.33	39	x 1.5
22	x 2	26.57	x 3.53	32.93	x 3.53	39	x 2.5
22	x 2.5	26.64	x 2.62	33	x 1.5	39	x 5
22	x 3	26.7	x 1.78	33	x 2	39.2	x 3
22	x 3.5	27	x 1.5	33	x 2.62	39.34	x 2.62
22	x 4	27	x 2	33	x 3	39.45	x 1.78
22	x 5	27	x 2.5	33	x 3.5	39.5	x 3
22	x 6	27	x 3	33.05	x 1.78	39.6	x 2.4
22.1	x 1.6	27	x 3.5	33.3	x 2.4	39.69	x 3.53
22.2	x 3	27	x 4	34	x 1.5	40	x 1.5
22.22	x 2.62	27	x 6	34	x 3	40	x 2
23	x 1	27.1	x 1.6	34	x 3.5	40	x 2.5
23	x 1.5	27.5	x 2.4	34	x 4	40	x 3
23	x 2	27.94	x 5.33	34	x 5	40	x 3.5
23	x 2.5	28	x 1.5	34.2	x 3	40	x 4
23	x 3	28	x 2	34.29	x 5.33	40	x 4.5
23	x 3.5	28	x 2.5	34.52	x 3.53	40	x 5
23	x 4	28	x 3	34.6	x 2.4	40	x 6
23	x 5	28	x 4	34.6	x 2.62	40.65	x 5.33
23.16	x 5.33	28	x 5	34.65	x 1.78	40.86	x 3.53
23.3	x 2.4	28	x 6	35	x 1.5	40.96	x 2.62
23.39	x 3.53	28.17	x 3.53	35	x 2	41	x 1.78
23.47	x 2.62	28.25	x 2.62	35	x 2.5	41	x 3
23.5	x 2.4	28.3	x 1.78	35	x 3	41	x 4
23.52	x 1.78	29	x 2	35	x 3.5	41	x 5
23.81	x 2.62	29	x 3.5	35	x 4	41.28	x 3.53
24	x 1	29.1	x 1.6	35	x 4.5	41.6	x 2.4
24	x 1.5	29.2	x 3	35	x 5	42	x 1.5
24	x 2	29.51	x 5.33	35	x 6	42	x 2
24	x 2.5	29.6	x 2.4	35.1	x 1.6	42	x 3
24	x 3	29.74	x 3.53	36	x 1.5	42	x 3.5
24	x 3.5	29.82	x 2.62	36	x 2	42	x 4
24	x 4	29.87	x 1.78	36	x 2.5	42	x 5
24	x 5	30	x 1	36	x 4	42	x 6
24	x 6	30	x 1.5	36	x 5	42	x 3
24.2	x 3	30	x 2	36	x 6	42.2	x 3
24.77	x 5.33	30	x 2.5	36.1	x 3.53	42.52	x 2.62
24.99	x 3.53	30	x 3	36.17	x 2.62	42.86	x 3.53
25	x 1	30	x 3.5	36.2	x 3	43	x 2
25	x 1.5	30	x 4	36.27	x 1.78	43	x 3
25	x 2	30	x 4.5	37	x 1.5	43	x 3.5
25	x 2.4	30	x 5	37	x 2	43	x 4
25	x 2.5	30	x 6	37	x 3	43	x 5

## O-ringen FPM - Viton®

afmetingen		afmetingen		afmetingen		afmetingen	
di	x s	di	x s	di	x s	di	x s
43.82	x 5.33	50	x 6	58	x 3.5	66	x 5
44	x 1.5	50.16	x 5.33	58	x 4	66.04	x 5.33
44	x 2	50.39	x 3.53	58	x 5	66.27	x 3.53
44	x 4	50.47	x 2.62	58	x 6	66.35	x 2.62
44	x 5	50.52	x 1.78	58.42	x 2.62	66.4	x 1.78
44	x 6	50.80	x 3.53	58.74	x 3.53	66.68	x 3.53
44.04	x 3.53	51	x 3.5	59	x 3	67	x 2.5
44.12	x 2.62	51	x 4	59.2	x 5.7	67	x 3
44.17	x 1.78	52	x 2	59.5	x 3	67	x 3.5
44.2	x 3	52	x 3	59.69	x 5.33	67	x 4
44.2	x 5.7	52	x 3.5	59.92	x 3.53	67.95	x 2.62
44.45	x 3.53	52	x 4	60	x 1.5	68	x 2
45	x 1.5	52	x 5	60	x 1.78	68	x 3
45	x 2	52	x 6	60	x 2	68	x 3.5
45	x 2.5	52.07	x 2.62	60	x 2.5	68	x 4
45	x 3	52.3	x 5.7	60	x 2.62	68	x 5
45	x 3.5	52.39	x 3.53	60	x 3	68	x 6
45	x 4	53	x 3	60	x 3.5	68.26	x 3.53
45	x 4.5	53	x 3.5	60	x 4	69	x 3.5
45	x 5	53	x 4	60	x 4.5	69.2	x 5.7
45	x 6	53	x 5	60	x 5	69.22	x 5.33
45.3	x 5.7	53.34	x 5.33	60	x 6	69.44	x 3.53
45.69	x 2.62	53.57	x 3.53	60.05	x 1.78	69.5	x 2.62
46	x 2	53.65	x 2.62	60.32	x 3.53	69.5	x 3
46	x 2.5	53.7	x 1.78	61.6	x 2.62	69.57	x 1.78
46	x 3	53.98	x 3.53	61.9	x 3.53	69.85	x 3.53
46	x 4	54	x 3	62	x 2	70	x 1.5
46	x 5	54	x 4	62	x 2.5	70	x 2
46.04	x 3.53	54	x 5	62	x 3	70	x 2.5
47	x 2	54	x 6	62	x 4	70	x 3
47	x 2.5	54.2	x 5.7	62	x 5	70	x 3.5
47	x 3	54.5	x 3	62	x 5.7	70	x 4
47	x 3.5	55	x 1.5	62.87	x 5.33	70	x 4.5
47	x 4	55	x 2	63	x 3	70	x 5
47	x 5.33	55	x 2.5	63	x 3.5	70	x 6
47.22	x 3.53	55	x 3	63	x 5	71	x 3
47.29	x 2.62	55	x 3.5	63.09	x 3.53	71	x 3.5
47.35	x 1.78	55	x 4	63.17	x 2.62	71.12	x 2.62
47.62	x 3.53	55	x 5	63.22	x 1.78	71.44	x 3.53
48	x 2	55	x 6	63.50	x 3.53	72	x 1.5
48	x 2.5	55.25	x 2.62	64	x 3	72	x 2.5
48	x 3	55.3	x 5.7	64	x 4	72	x 3
48	x 4	55.56	x 3.53	64	x 5	72	x 4
48	x 5	56	x 2	64	x 6	72	x 5
48	x 6	56	x 3	64.2	x 5.7	72.39	x 5.33
48.9	x 2.62	56	x 4	64.5	x 3	72.62	x 3.53
49	x 2.5	56	x 5	64.77	x 2.62	72.69	x 2.62
49	x 3	56	x 6	65	x 1.5	72.75	x 1.78
49	x 3.5	56.52	x 5.33	65	x 2	73	x 3
49.2	x 3.53	56.74	x 3.53	65	x 2.5	73	x 3.5
49.2	x 5.7	56.82	x 2.62	65	x 3	73	x 4.5
49.5	x 3	56.87	x 1.78	65	x 3.5	73.02	x 3.53
50	x 1.5	57	x 3	65	x 4	74	x 2
50	x 2	57	x 3.5	65	x 4.5	74	x 3
50	x 2.5	57	x 4	65	x 5	74	x 6
50	x 3	57	x 5	65	x 6	74.2	x 5.7
50	x 3.5	57.15	x 3.53	65.09	x 3.53	74.3	x 2.62
50	x 4	58	x 2	66	x 2.5	74.5	x 3
50	x 4.5	58	x 2.5	66	x 3	74.61	x 5.33
50	x 5	58	x 3	66	x 4	74.63	x 5.33

## O-ringen FPM - Viton®

afmetingen		afmetingen		afmetingen		afmetingen	
di	x s	di	x s	di	x s	di	x s
75	x 1.5	85	x 5	98	x 3	112	x 3
75	x 2	85	x 6	98	x 4	112	x 3.5
75	x 2.5	85	x 7	98	x 5	112	x 4
75	x 3	85.09	x 5.33	98.02	x 3.53	112	x 5
75	x 3.5	85.32	x 3.53	98.05	x 1.78	113.67	x 5.33
75	x 4	85.34	x 1.78	99	x 5.7	113.67	x 7
75	x 4.5	86	x 2	99.5	x 3	113.89	x 3.53
75	x 5	86	x 2.5	100	x 1.5	113.97	x 2.62
75	x 6	88	x 3	100	x 2	114.02	x 1.78
75.57	x 5.33	88	x 3.5			114.3	x 5.7
75.80	x 3.53	88	x 4	100	x 2.5	114.5	x 3
75.87	x 2.62	88	x 5	100	x 3	114.7	x 7
75.92	x 1.78	88	x 6	100	x 3.5	115	x 2.5
76	x 2	88.27	x 5.33	100	x 4	115	x 3
76	x 2.5	88.5	x 3.53	100	x 4.5	115	x 3.5
76	x 3	88.57	x 2.62	100	x 5	115	x 4
76	x 4	88.62	x 1.78	100	x 5.33	115	x 4.5
77.5	x 2.62	89	x 3.5	100	x 6	115	x 5
78	x 2	89.3	x 5.7	101	x 5.33	115	x 6
78	x 2.5	89.5	x 3	101.2	x 3.53	116.84	x 5.33
78	x 3	89.69	x 5.33	101.27	x 2.62	116.84	x 7
78	x 3.5	90	x 1.5	101.32	x 1.78	117.07	x 3.53
78	x 4	90	x 2	102	x 3.5	117.1	x 1.78
78	x 5	90	x 2.5	102	x 4	117.48	x 5.33
78	x 6	90	x 3	102	x 5	118	x 3
78.74	x 5.33	90	x 3.5	103	x 3	118	x 3.5
78.97	x 3.53	90	x 4	103	x 3.5	118	x 4
79	x 1.78	90	x 4.5	104.1	x 5.7	118	x 5
79.2	x 5.7	90	x 5	104.14	x 5.33	119	x 5.7
79.5	x 3	90	x 6	104.37	x 3.53	119.5	x 3
79.77	x 5.33	90	x 7	104.4	x 1.78	120	x 3
80	x 1.5	91.44	x 5.33	104.5	x 3	120	x 3.5
80	x 2	91.67	x 3.53	105	x 3	120	x 4
80	x 2.5	91.7	x 1.78	105	x 3.5	120	x 4.5
80	x 3	92	x 3	105	x 4	120	x 5
80	x 3.5	92	x 4	105	x 4.5	120	x 6
80	x 4	92	x 5	105	x 5	120.02	x 5.33
80	x 4.5	93	x 3	105	x 6	120.07	x 7
80	x 5	94	x 2	106	x 2	120.24	x 3.53
80	x 6	94	x 2.5	107.32	x 5.33	120.32	x 2.62
80.6	x 2.62	94.3	x 5.7	107.54	x 3.53	120.37	x 1.78
81.92	x 5.33	94.5	x 3	107.62	x 2.62	120.65	x 5.33
82	x 2	94.62	x 5.33	107.67	x 1.78	122	x 3
82	x 2.5	94.84	x 3.53	108	x 3	122	x 3.5
82	x 3	94.92	x 2.62	108	x 4	122	x 4
82.14	x 3.53	94.97	x 1.78	108	x 5	123.19	x 5.33
82.22	x 2.62	95	x 1.5	109.1	x 5.7	123.19	x 7
82.27	x 1.78	95	x 2	109.5	x 3	123.42	x 3.53
83	x 3.5	95	x 2.5	109.5	x 5.7	123.44	x 1.78
83.8	x 2.62	95	x 3	109.54	x 5.33	123.83	x 5.33
84	x 4	95	x 3.5	110	x 2.5	124	x 5.7
84.1	x 5.7	95	x 4	110	x 3	124.5	x 3
84.5	x 3	95	x 4.5	110	x 3.5	124.6	x 7
85	x 1.5	95	x 5	110	x 4	125	x 2.5
85	x 2	95	x 6	110	x 4.5	125	x 3
85	x 2.5	96	x 2.5	110	x 5	125	x 3.5
85	x 3	96	x 3	110	x 6	125	x 4
85	x 3.5	96	x 5	110.49	x 5.33	125	x 5
85	x 4	97.79	x 5.33	110.72	x 3.53	125	x 6
85	x 4.5	98	x 2.5	110.74	x 1.78	126.37	x 5.33

## O-ringen FPM - Viton®

afmetingen		afmetingen		afmetingen		afmetingen	
di	x s	di	x s	di	x s	di	x s
126.37	x 7	142	x 3	159.5	x 7	178	x 4
126.59	x 3.53	142	x 3.5	160	x 3	179.3	x 5.7
126.67	x 2.62	142	x 4	160	x 3.5	180	x 3
126.72	x 1.78	142.24	x 5.33	160	x 4	180	x 3.5
127	x 5.33	142.24	x 7	160	x 4.5	180	x 4
128	x 3	142.47	x 3.53	160	x 5	180	x 4.5
128	x 3.5	142.88	x 5.33	160	x 6	180	x 5
128	x 4	144.3	x 5.7	161.3	x 5.33	180	x 6
129.3	x 5.7	144.5	x 3	161.9	x 7	180	x 8
129.4	x 1.78	145	x 3	162	x 3	181	x 7
129.5	x 3	145	x 3.5	162	x 3.5	182	x 3
129.54	x 5.33	145	x 4	162	x 4	182	x 3.5
129.54	x 7	145	x 5	164.3	x 5.7	182	x 4
129.77	x 3.53	145	x 6	164.47	x 5.33	183.52	x 5.33
130	x 3	145.42	x 5.33	164.47	x 7	183.52	x 7
130	x 3.5	145.42	x 7	164.69	x 3.53	183.75	x 3.53
130	x 4	145.64	x 3.53	164.77	x 2.62	183.82	x 2.62
130	x 4.5	145.72	x 2.62	165	x 2	184.3	x 5.7
130	x 5	146.05	x 5.33	165	x 3	184.5	x 3
130	x 6	148	x 3	165	x 3.5	185	x 3
130.18	x 5.33	148	x 3.5	165	x 4	185	x 3.5
132	x 3	148	x 4	165	x 4.5	185	x 4
132	x 3.5	148.59	x 5.33	165	x 5	185	x 5
132	x 4	148.59	x 7	165	x 6	185	x 6
132	x 5	148.82	x 3.53	166.7	x 7	187.3	x 7
132.72	x 5.33	149.23	x 5.33	167.7	x 5.33	188	x 3
132.72	x 7	149.3	x 5.7	168	x 3	188	x 3.5
132.94	x 3.53	149.5	x 3	168	x 3.5	188	x 4
133.02	x 2.62	150	x 2.5	168	x 4	189.3	x 5.7
133.07	x 1.78	150	x 3	168.3	x 7	189.5	x 4.5
133.35	x 5.33	150	x 3.5	169.3	x 5.7	189.87	x 5.33
134.3	x 5.7	150	x 4	170	x 3	189.87	x 7
134.5	x 3	150	x 4.5	170	x 3.5	190	x 3
134.5	x 4.5	150	x 5	170	x 4	190	x 3.5
134.5	x 7	150	x 6	170	x 5	190	x 4
135	x 3	151.77	x 5.33	170	x 6	190	x 5
135	x 3.5	151.77	x 7	170	x 8	190	x 6
135	x 4	151.99	x 3.53	170.82	x 5.33	190.09	x 3.53
135	x 5	152	x 3	170.82	x 7	190.17	x 2.62
135	x 6	152	x 3.5	171.05	x 3.53	192	x 3
135.89	x 5.33	152	x 4	171.12	x 2.62	192	x 3.5
135.89	x 7	152.07	x 2.62	172	x 3	192	x 4
136.12	x 3.53	154.3	x 5.7	172	x 3.5	193.7	x 7
136.53	x 5.33	155	x 3	172	x 4	194.1	x 8.4
138	x 3	155	x 3.5	172	x 4.5	194.3	x 5.7
138	x 3.5	155	x 4	174	x 5.33	195	x 3
138	x 4	155	x 5	174.3	x 5.7	195	x 3.5
139.07	x 5.33	155	x 5.33	174.6	x 7	195	x 4
139.07	x 7	155	x 6	175	x 2.5	195	x 5
139.29	x 3.53	155.6	x 7	175	x 3	195	x 6
139.3	x 5.7	158	x 3	175	x 3.5	196.22	x 5.33
139.37	x 2.62	158	x 3.5	175	x 4	196.22	x 7
139.5	x 3	158	x 4	175	x 5	196.44	x 3.53
139.7	x 5.33	158	x 5	175	x 6	196.52	x 2.62
140	x 3	158.12	x 5.33	177.17	x 5.33	198	x 3
140	x 3.5	158.12	x 7	177.17	x 7	198	x 3.5
140	x 4	158.34	x 3.53	177.39	x 3.53	198	x 4
140	x 4.5	158.42	x 2.62	177.47	x 2.62	199.1	x 8.4
140	x 5	159.3	x 5.7	178	x 3	199.3	x 5.7
140	x 6	159.5	x 3	178	x 3.5	200	x 3

## O-ringen FPM - Viton®

afmetingen		afmetingen		afmetingen		afmetingen	
di	x s	di	x s	di	x s	di	x s
200	x 3.5	230	x 3.5	270	x 6	329.79	x 3.53
200	x 4	230	x 4	275	x 3.5	330	x 3.5
200	x 5	230	x 5	275	x 4	330	x 4
200	x 6	230	x 6	278.77	x 5.33	330	x 5
200	x 7	234.22	x 5.33	278.77	x 7	330	x 6
200	x 8	234.32	x 7	278.99	x 3.53	330	x 8
202.57	x 5.33	234.54	x 3.53	279.3	x 5.7	335	x 3.5
202.57	x 7	235	x 3	280	x 3.5	339.3	x 5.7
202.8	x 3.53	235	x 3.5	280	x 4	340	x 3.5
202.87	x 2.62	235	x 4	280	x 5	340	x 4
205	x 3	235	x 5	280	x 6	340	x 5
205	x 3.5	235	x 6	280	x 8	340	x 6
205	x 4	239.3	x 5.7	285	x 3.5	342.27	x 7
205	x 5	240	x 3	285	x 4	345	x 3
205	x 6	240	x 3.5	285.1	x 7	345	x 3.5
205	x 7	240	x 4	289.3	x 5.7	345	x 4
208	x 4.5	240	x 5	290	x 3	345	x 5
208.92	x 5.33	240	x 6	290	x 3.5	350	x 3.5
208.92	x 7	240.67	x 5.33	290	x 4	350	x 4
209.15	x 3.53	240.67	x 7	290	x 5	350	x 5
209.22	x 2.62	240.9	x 3.53	290	x 6	350	x 6
209.3	x 5.7	245	x 3	291.47	x 5.33	354.97	x 5.33
210	x 3	245	x 3.5	291.47	x 7	354.97	x 7
210	x 3.5	245	x 4	291.69	x 3.53	355	x 3.5
210	x 4	245	x 5	295	x 3.5	355.19	x 3.53
210	x 5	247	x 7	295	x 4	359.3	x 5.7
210	x 6	247.02	x 5.33	297.8	x 7	360	x 3.5
215	x 3	247.25	x 3.53	299.3	x 5.7	360	x 4
215	x 3.5	247.32	x 2.62	300	x 3.5	360	x 5
215	x 4	249.3	x 5.7	300	x 4	360	x 6
215	x 5	250	x 3	300	x 5	365	x 3.5
215	x 6	250	x 3.5	300	x 6	365	x 4
215	x 10	250	x 4	300	x 8	367.67	x 7
215.27	x 5.33	250	x 4.5	304.17	x 5.33	370	x 3.5
215.27	x 7	250	x 5	304.17	x 7	370	x 4
215.5	x 3.53	250	x 6	304.39	x 3.53	370	x 5
215.57	x 2.62	250	x 10	305	x 3	370	x 6
218.5	x 4.5	253.37	x 5.33	305	x 3.5	375	x 3.5
219.3	x 5.7	253.37	x 7	305	x 5	375	x 5
220	x 3	253.59	x 3.53	310	x 3	379.3	x 5.7
220	x 3.5	255	x 3.5	310	x 3.5	380	x 3.5
220	x 4	255	x 4	310	x 4	380	x 4
220	x 5	258	x 5	310	x 5	380	x 5
220	x 6	259.3	x 5.7	310	x 6	380	x 6
221.62	x 5.33	259.7	x 7	315	x 3.5	380	x 8
221.62	x 7	260	x 3.5	315	x 5	380	x 10
221.8	x 3.53	260	x 4	316.89	x 7	380.37	x 5.33
221.92	x 2.62	260	x 5	319.3	x 5.7	380.37	x 7
225	x 3	260	x 6	320	x 3	380.59	x 3.53
225	x 3.5	260	x 8	320	x 3.5	385	x 3.5
225	x 4	265	x 3.5	320	x 4	390	x 3.5
225	x 5	265	x 4	320	x 5	390	x 4
225	x 6	265	x 5	320	x 6	390	x 5
227	x 4.5	266.07	x 5.33	320	x 10	390	x 6
227.97	x 5.33	266.07	x 7	325	x 3.5	393.1	x 7
227.97	x 7	266.29	x 3.53	325	x 5	395	x 3.5
228.19	x 3.53	269.3	x 5.7	325	x 7	399.3	x 5.7
228.27	x 2.62	270	x 3.5	329.3	x 5.7	400	x 3
229.3	x 5.7	270	x 4	329.57	x 5.33	400	x 3.5
230	x 3	270	x 5	329.57	x 7	400	x 4

## O-ringen FPM - Viton®

afmetingen		afmetingen		afmetingen		afmetingen	
di	x s	di	x s	di	x s	di	x s
400	x 5						
400	x 6						
405.26	x 3.53						
405.26	x 5.33						
405.26	x 7						
410	x 3.5						
410	x 4						
415	x 5						
415	x 6						
417,96	x 7						
419.3	x 5.7						
420	x 3.5						
420	x 4						
420	x 5						
429	x 6						
430	x 3.5						
430	x 4						
430.66	x 3.53						
430.66	x 5.33						
430.66	x 7						
439.3	x 5.7						
440	x 3.5						
440	x 4						
443.35	x 7						
450	x 4						
450	x 6						
455	x 8						
456.06	x 3.53						
456.06	x 5.33						
456.06	x 7						
459.3	x 5.7						
460	x 3						
468.76	x 7						
480	x 4						
480	x 6						
481.38	x 5.33						
481.46	x 7						
490	x 8						
494.16	x 7						
500	x 5						
500	x 8						
506.78	x 5.33						
506.86	x 7						
510	x 10						
530	x 10						
532.26	x 5.33						
532.26	x 7						
540	x 6						
557.68	x 5.33						
557.68	x 7						
570	x 8						
582.68	x 5.33						
582.68	x 7						
608.08	x 5.33						
608.08	x 7						
647.07	x 7						
658.88	x 5.33						
658.88	x 7						

## O-ringen precisiesnoer

NBR 70	FPM	EPDM	NEOPRENE	SILICONE
1.6	1.6	1.6	3	4
1.78	1.78	1.78	3.5	5
2	2	2	4	5.7
2.4	2.4	2.62	5	6
2.5	2.62	3	6	7
2.62	3	3.53	7	8
3	3.53	4	8	9
3.53	4	5	10	10
4	5	5.33	12	12
4.5	5.33	5.7	13	16
5	5.7	6	14	18
5.33	6	7	15	
5.7	7	8	16	
6	8	10		
7	9			
8	10			
8.4	12			
9	13			
10	15			
11				
12				
13				
14				
15				
16				
18				
20				
22				
25				
30				
40				

## O-ringkit LOCTITE

Deze montagekit van loctite is speciaal samengesteld om zelf O-ringen op iedere gewenste maat te maken.

De inhoud van deze kit bestaat uit vijf verschillende diameters snoer.

Een flacon loctite secondenlijm.

Een flacon loctite reinigingsvloeistof.

Een mal met maten voor iedere snoerdiameter.

Een scherp mesje om glad en haaks af te snijden.

## Assortimentdozen precisie O-ringen **NBR 70 - FPM 75**

Doos no.: 1

Aantal 355

20x 2,9 x 1,78	20x 3,69 x 1,78	20x 4,48 x 1,78	20x 5,28 x 1,78	20x 6,07 x 1,78
20x 6,75 x 1,78	20x 7,66 x 1,78	20x 8,73 x 1,78	15x 9,25 x 1,78	15x 10,82 x 1,78
15x 11,11 x 1,78	15x 9,19 x 2,62	15x 9,92 x 2,62	10x 10,98 x 2,62	10x 12,37 x 2,62
10x 13,10 x 2,62	10x 13,95 x 2,62	10x 15,08 x 2,62	10x 17,13 x 2,62	10x 18,72 x 2,62
5x 20,24 x 2,62	5x 21,89 x 2,62	5x 22,22 x 2,62	5x 23,47 x 2,62	5x 18,64 x 3,53
5x 20,22 x 3,53	5x 21,82 x 3,53	5x 23,40 x 3,53	5x 24,99 x 3,53	5x 26,58 x 3,53

Doos no.: 2

Aantal 290

20x 12,42 x 1,78	20x 15,60 x 1,78	20x 20,35 x 1,78	20x 25,07 x 2,62	20x 26,65 x 2,62	20x 28,25 x 2,62
15x 29,82 x 2,62	15x 31,42 x 2,62	15x 28,17 x 3,53	15x 29,75 x 3,53	10x 31,34 x 3,53	10x 32,93 x 3,53
10x 34,52 x 3,53	10x 36,10 x 3,53	10x 37,69 x 3,53	10x 40,86 x 3,53	10x 44,04 x 3,53	10x 47,22 x 3,53
5x 50,39 x 3,53	5x 37,47 x 5,34	5x 40,65 x 5,34	5x 43,82 x 5,34	5x 47,00 x 5,34	5x 50,16 x 5,34

Doos no.: 3

Aantal 525

20x 4 x 1,5	20x 5 x 1,5	20x 6 x 1,5	20x 7 x 1,5	20x 8 x 1,5
20x 6 x 2	20x 8 x 2	20x 10 x 2	20x 12 x 2	20x 14 x 2
20x 6,6 x 2,4	20x 8,6 x 2,4	20x 10,6 x 2,4	20x 12,6 x 2,4	20x 14,6 x 2,4
20x 5 x 2,5	20x 7 x 2,5	20x 10 x 2,5	20x 12 x 2,5	20x 15 x 2,5
15x 10x x 3	15x 12 x 3	15x 15 x 3	15x 18 x 3	15x 20 x 3
10x 22 x 3	10x 24 x 3	10x 26 x 3	10x 30 x 3	10x 32 x 3

Doos no.: 4

Aantal 290

15x 16 x 2	15x 18 x 2	15x 20 x 2	15x 22 x 2	15x 25 x 2	15x 30 x 2
15x 25 x 3	15x 28 x 3	15x 30 x 3	10x 35 x 3	10x 38 x 3	10x 40 x 3
15x 25 x 4	15x 30 x 3	15x 35 x 4	15x 40 x 4	10x 45 x 4	10x 50 x 4
10x 25 x 5	10x 30 x 5	10x 35 x 5	10x 40 x 5	5x 45 x 5	5x 50 x 5



## **Back-up ringen**

Boven 100 bar is het aan te raden een back-up ring toe te passen om het wegpersen van de O-ring te voorkomen.

Deze back-up ringen zijn in diverse uitvoeringen leverbaar uit verschillende materialen.

De meest gangbare back-up ring is geheel uit Teflon op maat van de O-ring gedraaid.

De dikte van de back-up ring is aan te passen aan de gevraagde werkdruk.

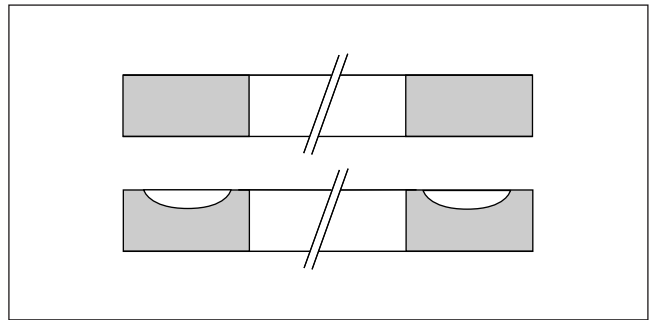

## **Teflon kompakt stang en zuigerafdichting**

De Kompakt afdichting is zowel voor hydrauliek als pneumatiek geschikt. Door de geringe inbouwmaten en het lage wrijvingscoëfficiënt worden deze afdichtingen in samenwerking met de bijbehorende O-ring steeds meer met succes toegepast.

Deze Kompakt afdichting is leverbaar geheel op maat volgens uw opgave.

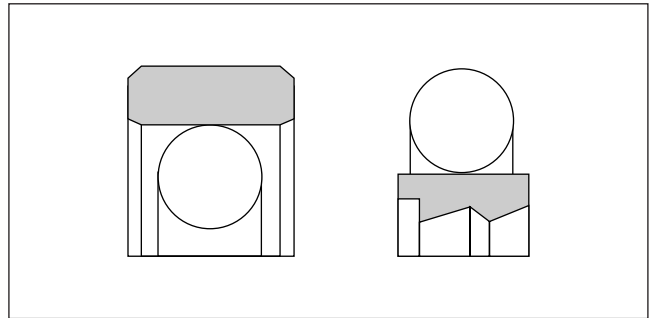

## **Teflon O-ringen**

Door gebruik te maken van de Seal-jet is het mogelijk haast elke Teflon O-ring tot en met 530 mm uitwendig, op maat voor u te maken.

## **Synthetisch speciaal vet**

Omdat de wrijvingscoëfficiënten van elastomeren op staal hoog zijn, levert dit problemen op bij de montage van o.a. O-ringen, oliekeer-ringen en manchetten.

In de praktijk worden veel afdichtingen droog gemonteerd, waardoor reeds vanaf de montage beschadigingen ontstaan.

Door de te monteren afdichtingen licht in te vetten met Kluber vet Silubrin Grease I, voorkomt u dit probleem.

Prijzen en meer technische informatie omtrent deze Kluber vetsoort verstrekken wij u graag op aanvraag.

## Meetkegels

Meetkegels verlichten het soms zeer tijdrovende meten van allerhande ringen. De binnendiameter van O-ringen, Quad-ringen, flensafdichtingen, steunringen en in het bijzonder spiraal back-up ringen zijn eenvoudig en zeker te bepalen door de meetkegel.

Bij de standaarduitvoering zijn de kegels trapsgewijs met steeds 1 mm stijging aangegeven.

Kegels met een nog fijnere aanduiding zijn op aanvraag leverbaar.

Een meetset bestaat uit vier kunststof kegels van 5 tot 200 mm.

De verschillende kegels kunnen worden samen gesteld of afzonderlijk worden gebruikt met hun eigen bodemplaat.

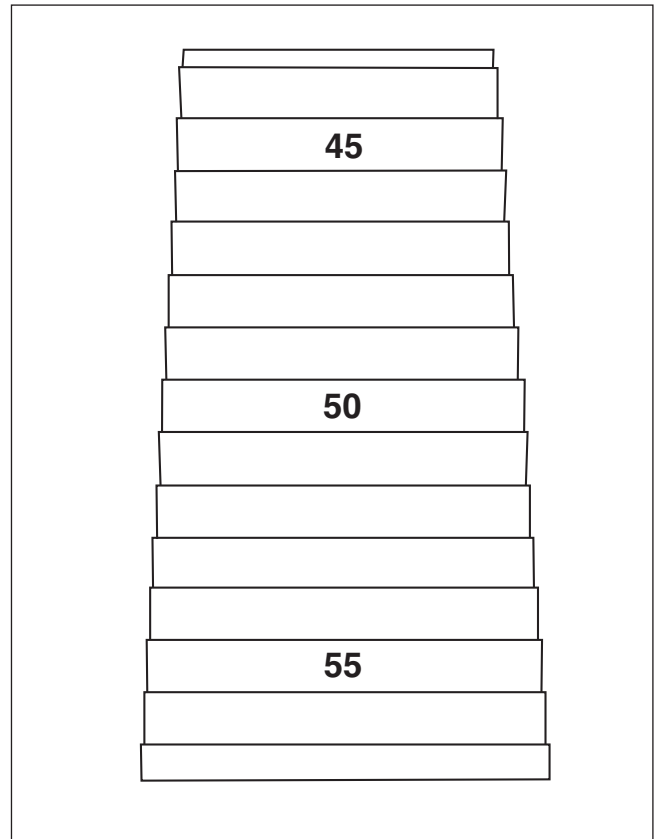

Elke trap is 7.5 mm hoog, zodat ook hogere onderdelen kunnen worden gemeten.

Op elke vijfde trap staan de mm vermeld.

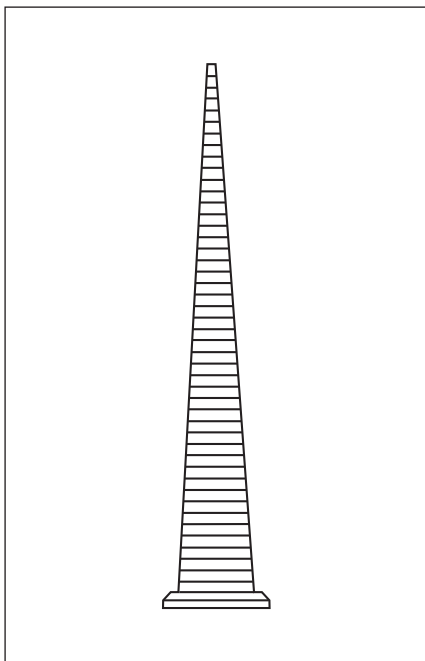

### Meetkegel 1

Meetbereik 5 tot 50 mm

Oplopend per mm

Hoogte 345 mm

Bodemplaat afneembaar

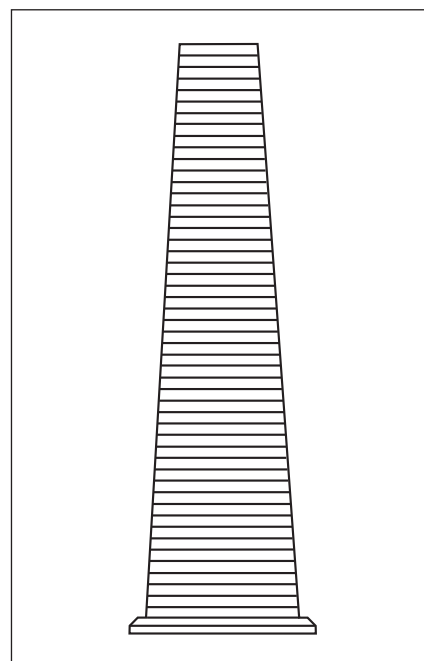

### Meetkegel 2

Meetbereik 51 tot 100 mm

Oplopend per mm

Hoogte 375 mm

Bodemplaat afneembaar

De complete meetset bestaat uit 4 afzonderlijke kegels, die na het afnemen van de bodemplaat samengesteld kunnen worden tot 1 kegel met een hoogte van 1470 mm.

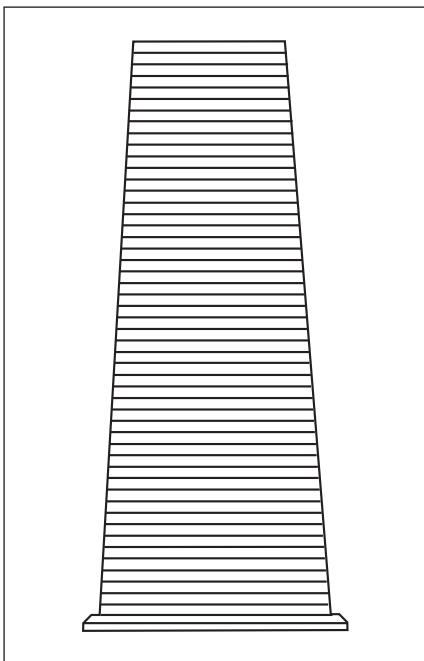
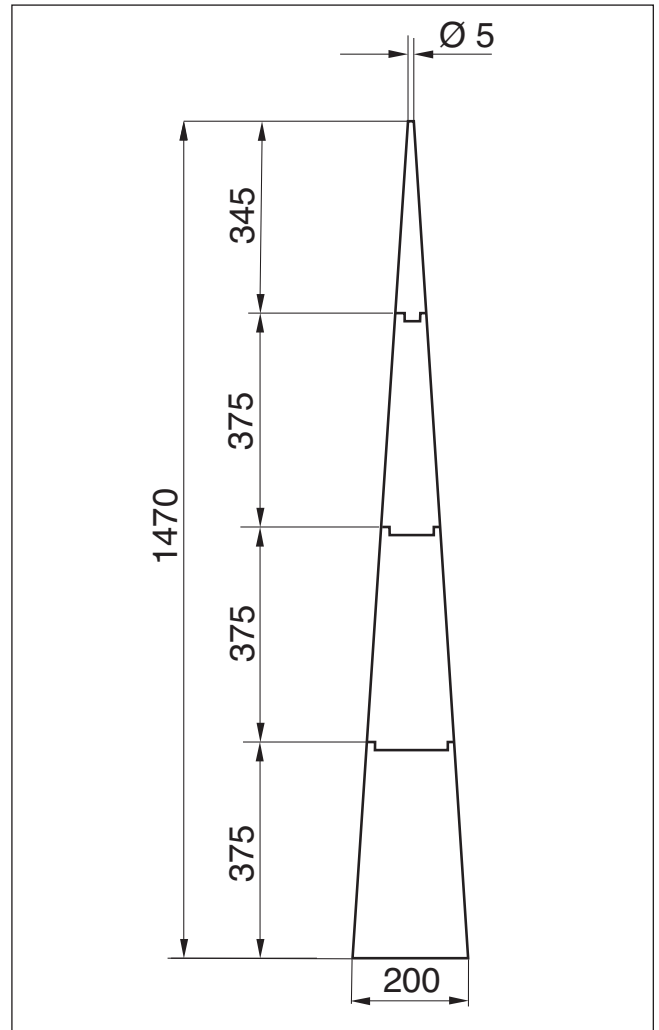

**Meetekegel 3**  
Meetbereik 101 tot 150 mm  
Oplopend per mm  
Hoogte 375 mm  
Bodemplaat afneembaar

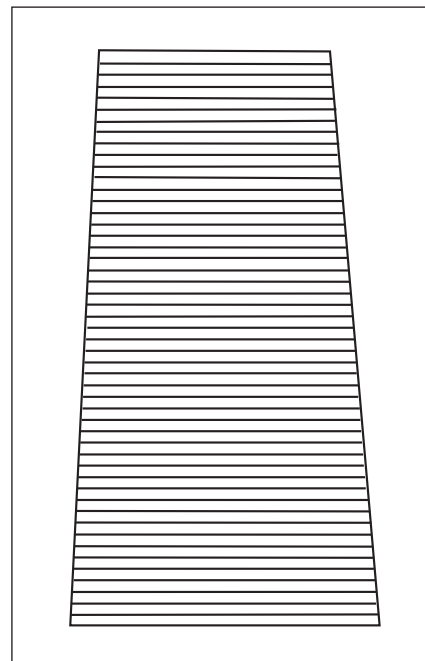

**Meetekegel 4**  
Meetbereik 151 tot 200 mm  
Oplopend per mm  
Hoogte 375 mm  
Bodemplaat afneembaar

## Precisie Quad-ringen NBR 80 - FPM

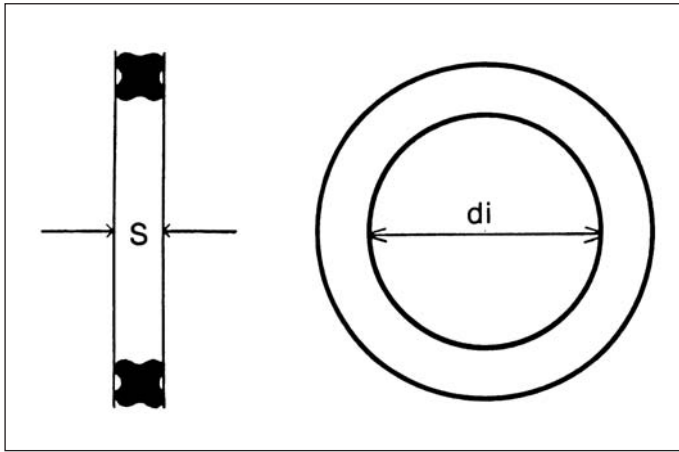

Quadringen zijn dubbelwerkende zelfdichtende vierlippenringen met grote afdichtingsmogelijkheden voor zowel hydrauliek als pneumatiek.

Ten opzichte van de O-ring heeft hij diverse voordelen.

Bij dynamisch gebruik komen deze voordelen het meest naar voren.

De O-ring kan gaan rollen in zijn groef, de Quadring echter gaat schuiven, waardoor geen nadelige gevolgen ontstaan.

Door zijn vormgeving ontstaat minder wrijving en bij dynamisch gebruik vormt hij zelf een smeergroef.

Ook het afdichtend vermogen van de Quadring ligt hoger dan bij de O-ring.

### Quadringen NBR 80

di	x s	di	x s	di	x s	di	x s	di	x s	di	x s
1.78	x 1.78	17.12	x 2.62	64.77	x 2.62	75.79	x 3.53	107.32	x 5.33	158.12	x 6.99
2.90	x 1.78	18.72	x 2.62	69.50	x 2.62	78.97	x 3.53	110.49	x 5.33	164.47	x 6.99
3.60	x 1.78	20.29	x 2.62	9.12	x 3.53	82.14	x 3.53	113.67	x 5.33	170.82	x 6.99
4.47	x 1.78	21.89	x 2.62	10.69	x 3.53	85.32	x 3.53	120.02	x 5.33	177.17	x 6.99
5.28	x 1.78	23.47	x 2.62	15.47	x 3.53	88.49	x 3.53	123.19	x 5.33	183.52	x 6.99
6.07	x 1.78	25.07	x 2.62	13.87	x 3.53	91.67	x 3.53	126.37	x 5.33	189.87	x 6.99
7.65	x 1.78	26.64	x 2.62	18.64	x 3.53	94.84	x 3.53	129.54	x 5.33	196.22	x 6.99
9.25	x 1.78	28.25	x 2.62	20.22	x 3.53	98.02	x 3.53	132.72	x 5.33	202.57	x 6.99
10.82	x 1.78	29.85	x 2.62	21.82	x 3.53	37.47	x 5.33	135.89	x 5.33	215.27	x 6.99
12.42	x 1.78	31.,42	x 2.62	23.39	x 3.53	40.64	x 5.33	139.07	x 5.33	227.97	x 6.99
14.00	x 1.78	32.99	x 2.62	24.99	x 3.53	43.82	x 5.33	142.24	x 5.33		
15.60	x 1.78	34.60	x 2.62	26.57	x 3.53	46.99	x 5.33	164.47	x 5.33		
17.17	x 1.78	36.17	x 2.62	28.17	x 3.53	50.17	x 5.33	170.82	x 5.33		
18.77	x 1.78	37.77	x 2.62	29.74	x 3.53	53.34	x 5.33	177.17	x 5.33		
20.35	x 1.78	39.34	x 2.62	31.34	x 3.53	56.52	x 5.33	183.52	x 5.33		
21.95	x 1.78	40.94	x 2.62	32.92	x 3.53	59.69	x 5.33	189.87	x 5.33		
23.52	x 1.78	42.,52	x 2.62	34.52	x 3.53	62.87	x 5.33	221.62	x 5.33		
25.12	x 1.78	44.12	x 2.62	36.10	x 3.53	66.04	x 5.33	113.67	x 6.99		
26.70	x 1.78	45.69	x 2.62	37.69	x 3.53	69.22	x 5.33	116.84	x 6.99		
28.30	x 1.78	47.29	x 2.62	40.87	x 3.53	72.39	x 5.33	120.02	x 6.99		
29.87	x 1.78	48.90	x 2.62	44.04	x 3.53	75.57	x 5.33	123.19	x 6.99		
31.47	x 1.78	50.47	x 2.62	47.22	x 3.53	78.74	x 5.33	126.37	x 6.99		
33.05	x 1.78	52.07	x 2.62	50.39	x 3.53	81.92	x 5.33	129.54	x 6.99		
34.65	x 1.78	53.65	x 2.62	53.57	x 3.53	85.09	x 5.33	132.72	x 6.99		
37.82	x 1.78	55.25	x 2.62	56.74	x 3.53	88.27	x 5.33	135.89	x 6.99		
9.19	x 2.62	56.82	x 2.62	59.92	x 3.53	91.44	x 5.33	139.07	x 6.99		
10.77	x 2.62	58.42	x 2.62	63.09	x 3.53	94.62	x 5.33	142.24	x 6.99		
12.37	x 2.62	60.00	x 2.62	66.27	x 3.53	97.79	x 5.33	145.42	x 6.99		
13.94	x 2.62	61.60	x 2.62	69.44	x 3.53	100.97	x 5.33	148.59	x 6.99		
15.54	x 2.62	63.17	x 2.62	72.62	x 3.53	104.14	x 5.33	151.77	x 6.99		

## Materiaal

De afstrijker wordt meestal geleverd met een NBR manchet met of zonder metalen versterking.  
Bij hogere temperaturen of als er een hoge slijtvastheid wordt vereist, kunnen afstrijkers ook geleverd worden uit Viton®, polyurethane of Teflon.

## Uitvoering

Er zijn vier verschillende uitvoeringen in NBR uit voorraad leverbaar.  
Met de SEAL-JET is het mogelijk vrijwel direct tot 530 mm uitwendig de andere materialen te leveren.

## Type AS

De AS uitvoering is vervaardigd uit NBR met een metalen uitwendige versterkingsring. Dit type is het meest eenvoudig te monteren. Een perspassing H8 is over het algemeen voldoende.

## Type ASOB6

De ASOB6 wordt geheel uit NBR geleverd. Hierdoor is het mogelijk om deze afstrijker zonder veel moeite in een kamer te steken. Bij een te kleine binnendiameter raden wij aan een gedeelde constructie toe te passen.

## Type AS7

De AS7 is gelijk aan de AS met dit verschil dat nu de metalen versterkingsring is ingevulcaniseerd. Het voordeel van deze uitvoering is dat de afstrijker niet door roestvorming vast kan komen te zitten.  
Bij de montage moet de kamer wel van een zoekrand worden voorzien zodat opstropen van de rubber buitenmantel achterwege blijft.

## Type ASOB8

De ASOB8 is evenals de ASOB6 geheel uit NBR vervaardigd maar trapsgewijs uitgevoerd. Hierdoor komt de afstrijker steviger in zijn huis te zitten en wordt de afstrijker extra ondersteund.

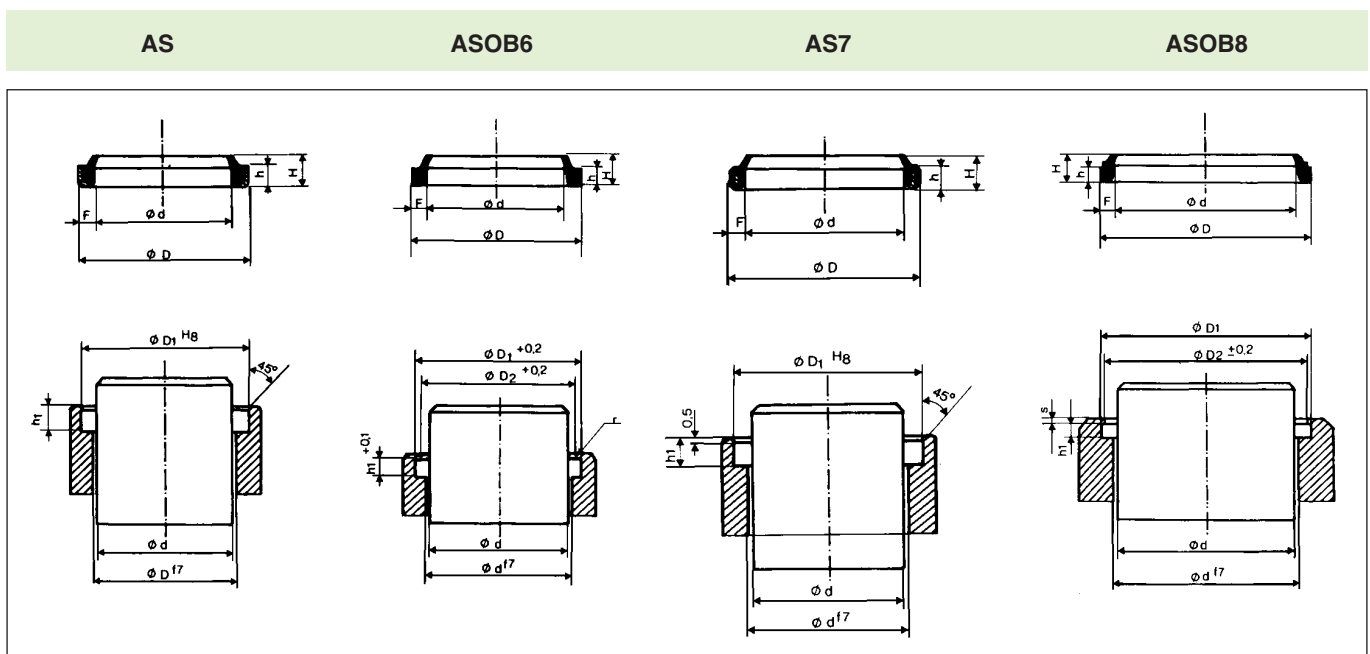

## Afstrijkers type AS NBR 90

afmetingen					inbouwmaten			
d	x	D	h	x	H	D1	h1	
10	x	16	x	3	x	4.5	16	3
10	x	20	x	5	x	8	20	5
12	x	20	x	4	x	6	20	4
12	x	22	x	5	x	8	22	5
14	x	22	x	3	x	4	22	3
14	x	25	x	5	x	8	25	5
15	x	25	x	5	x	8	25	5
15	x	25	x	7	x	10	25	7
16	x	22	x	3	x	4	22	3
16	x	26	x	5	x	8	26	5
18	x	28	x	7	x	10	28	7
20	x	28	x	3.5	x	5	28	3.5
20	x	30	x	4	x	6	30	4
20	x	30	x	7	x	10	30	7
20	x	35	x	7	x	10	35	7
22	x	28	x	5	x	9	28	5
22	x	32	x	7	x	10	32	7
22	x	35	x	7	x	10	35	7
24	x	37	x	7	x	10	37	7
25	x	35	x	5	x	7	35	5
25	x	35	x	7	x	10	35	7
26	x	34	x	5	x	8	34	5
28	x	40	x	7	x	10	40	7
30	x	40	x	5	x	8	40	5
30	x	40	x	7	x	10	40	7
32	x	45	x	7	x	10	45	7
35	x	45	x	7	x	10	45	7
36	x	45	x	7	x	10	45	7
40	x	50	x	5	x	8	50	5
40	x	50	x	7	x	10	50	7
40	x	52	x	7	x	10	52	7
42	x	52	x	7	x	10	52	7
45	x	55	x	7	x	10	55	7
45	x	60	x	7	x	10	60	7
50	x	56	x	5	x	7	56	5
50	x	60	x	5	x	8	60	5
50	x	60	x	7	x	10	60	7
50	x	65	x	5	x	8	65	5
52	x	62	x	7	x	10	62	7
55	x	63	x	7	x	10	63	7
55	x	65	x	7	x	10	65	7
56	x	65	x	7	x	10	65	7
60	x	70	x	7	x	10	70	7
60	x	74	x	5	x	8	74	5
60	x	75	x	7	x	10	75	7
60	x	78	x	11	x	15	78	11
60	x	80	x	7	x	10	80	7
63	x	75	x	7	x	10	75	7
65	x	75	x	7	x	10	75	7
70	x	80	x	7	x	10	80	7
75	x	85	x	7	x	10	85	7
80	x	90	x	7	x	10	90	7
80	x	100	x	12	x	15	100	12
85	x	95	x	7	x	10	95	7
90	x	100	x	7	x	10	100	7
95	x	105	x	7	x	10	105	7
100	x	110	x	7	x	10	110	7
105	x	115	x	7	x	10	115	7
110	x	120	x	7	x	10	120	7
115	x	125	x	7	x	10	125	7

afmetingen					inbouwmaten			
d	x	D	h	x	H	D1	h1	
120	x	130	x	7	x	10	130	7
125	x	140	x	9	x	12	140	9
130	x	145	x	9	x	12	145	9
135	x	150	x	9	x	12	150	9
140	x	155	x	9	x	12	155	9
145	x	160	x	9	x	12	160	9
145	x	165	x	10	x	15	165	10
150	x	165	x	9	x	12	165	9
160	x	175	x	9	x	12	175	9
170	x	185	x	10	x	14	185	10
180	x	195	x	10	x	14	195	10
200	x	220	x	12	x	16	220	12
210	x	230	x	10	x	15	230	10
220	x	240	x	12	x	16	240	12

## Afstrijkers type AS7 NBR 90

afmetingen					inbouwmaten			
d	x	D	x	h	x	H	D1	h1
6	x	13	x	3	x	4.5	13	3
8	x	14	x	3.5	x	5	14	3.5
10	x	16	x	3.5	x	5	16	3.5
10	x	20	x	5	x	8	20	5
12	x	18	x	3.5	x	5	18	3.5
12	x	22	x	5	x	8	22	5
14	x	20	x	3.5	x	5	20	3.5
15	x	21	x	3.5	x	5	21	3.5
15	x	25	x	5	x	8	25	5
16	x	22	x	3.5	x	5	22	3.5
16	x	24	x	3.5	x	5	24	3.5
16	x	26	x	5	x	8	26	5
17	x	22	x	5	x	7	22	5
18	x	28	x	5	x	7	28	5
20	x	30	x	5	x	7	30	5
20	x	30	x	7	x	10	30	7
22	x	32	x	5	x	7	32	5
22	x	32	x	7	x	10	32	7
24	x	35	x	5	x	8	35	5
25	x	35	x	5	x	7	35	5
25	x	35	x	7	x	10	35	7
26	x	35	x	7	x	10	35	7
28	x	38	x	5	x	7	38	5
28	x	40	x	7	x	10	40	7
30	x	40	x	5	x	7	40	5
30	x	40	x	7	x	10	40	7
32	x	42	x	5	x	7	42	5
32	x	45	x	7	x	10	45	7
35	x	45	x	7	x	10	45	7
36	x	45	x	7	x	10	45	7
36	x	46	x	5	x	7	46	5
38	x	48	x	7	x	10	48	7
40	x	50	x	5	x	8	50	5
40	x	50	x	7	x	10	50	7
42	x	52	x	5	x	7	52	5
42	x	52	x	7	x	10	52	7
45	x	55	x	5	x	7	55	5
45	x	55	x	7	x	10	55	7
48	x	60	x	7	x	10	60	7
50	x	56	x	5	x	7	56	5
50	x	60	x	5	x	7	60	5
50	x	60	x	7	x	10	60	7
52	x	62	x	7	x	10	62	7
55	x	65	x	5	x	7	65	5
55	x	65	x	7	x	10	65	7
56	x	66	x	5	x	7	66	5
60	x	70	x	5	x	7	70	5
60	x	70	x	7	x	10	70	7
63	x	73	x	5	x	7	73	5
65	x	75	x	5	x	7	75	5
65	x	75	x	7	x	10	75	7
70	x	80	x	5	x	7	80	5
70	x	80	x	7	x	10	80	7
75	x	83	x	7	x	10	83	7
75	x	85	x	7	x	10	85	7
80	x	88	x	7	x	10	88	7
80	x	90	x	7	x	10	90	7
85	x	95	x	7	x	10	95	7
90	x	100	x	5	x	7	100	5
90	x	100	x	7	x	10	100	7

afmetingen					inbouwmaten			
d	x	D	x	h	x	H	D1	h1
95	x	105	x	7	x	10	105	7
100	x	110	x	7	x	10	110	7
105	x	115	x	7	x	10	115	7
110	x	120	x	7	x	10	120	7
115	x	125	x	7	x	10	125	7
120	x	130	x	7	x	10	130	7
125	x	140	x	9	x	12	140	9
130	x	145	x	9	x	12	145	9
140	x	155	x	9	x	12	155	9
150	x	165	x	9	x	12	165	9
160	x	175	x	9	x	12	175	9
170	x	185	x	10	x	14	185	10
180	x	195	x	10	x	14	195	10
200	x	220	x	12	x	16	220	12
220	x	240	x	12	x	16	240	12

### Afstrijkers type ASOB6 NBR 90

afmetingen						inbouwmaten			
d	x	D	x	h	x	H	D1	D2	h1
20	x	28	x	5	x	7	28.6	23	5.3
22	x	30	x	5	x	7	30.6	25	5.3
25	x	33	x	5	x	7	33.6	28	5.3
28	x	36	x	5	x	7	36.6	31	5.3
30	x	38	x	5	x	7	38.6	33	5.3
32	x	40	x	5	x	7	40.6	35	5.3
35	x	43	x	5	x	7	43.6	38	5.3
36	x	44	x	5	x	7	44.6	39	5.3
40	x	48	x	5	x	7	48.6	43	5.3
42	x	50	x	5	x	7	50.6	45	5.3
45	x	55	x	5	x	7	55.6	48	5.3
50	x	58	x	5	x	7	58.6	53	5.3
50	x	60	x	5	x	7	60.6	53	5.3
55	x	65	x	5	x	7	65.6	58	5.3
56	x	66	x	5	x	7	66.6	59	5.3
60	x	68	x	5	x	7	68.6	63	5.3
60	x	70	x	5	x	7	70.6	63	5.3
63	x	73	x	5	x	7	73.6	66	5.3
65	x	75	x	5	x	7	75.6	68	5.3
70	x	80	x	5	x	7	80.6	73	5.3
75	x	87	x	7	x	12	87.2	81	7.1
80	x	92	x	7	x	12	92.2	86	7.1
85	x	97	x	7	x	12	97.2	91	7.1
90	x	102	x	7	x	12	102.2	96	7.1
95	x	107	x	7	x	12	107.2	101	7.1
100	x	112	x	7	x	12	112.2	106	7.1
110	x	122	x	7	x	12	122.2	116	7.1
115	x	127	x	7	x	12	127.2	121	7.1
120	x	132	x	7	x	12	132.2	126	7.1
125	x	140	x	10	x	16	140	132.6	10.1
140	x	155	x	10	x	16	155	147.6	10.1
150	x	165	x	10	x	16	165	157.6	10.1
160	x	175	x	10	x	16	175	167.6	10.1
180	x	200	x	10	x	18	200	190	10.2
200	x	220	x	10	x	18	220	210	10.2

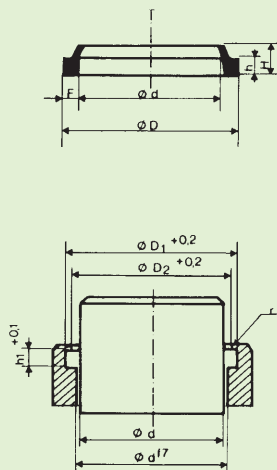

### Afstrijkers type ASOB8 NBR 90

afmetingen						inbouwmaten			
d	x	D	x	h	x	H	D1	D2	h1
8	x	16	x	4	x	7	16	14	4.15
10	x	18	x	4	x	7	18	16	4.15
12	x	20	x	4	x	7	20	18	4.15
14	x	22	x	4	x	7	22	20	4.15
16	x	24	x	4	x	7	24	22	4.15
18	x	26	x	4	x	7	26	24	4.15
20	x	28	x	4	x	7	28	26	4.15
22	x	30	x	4	x	7	30	28	4.15
25	x	33	x	4	x	7	33	31	4.15
28	x	36	x	4	x	7	36	34	4.15
30	x	38	x	4	x	7	38	36	4.15
32	x	40	x	4	x	7	40	38	4.15
35	x	43	x	4	x	7	43	41	4.15
36	x	44	x	4	x	7	44	42	4.15
40	x	48	x	4	x	7	48	46	4.15
42	x	50	x	4	x	7	50	48	4.15
45	x	53	x	4	x	7	53	51	4.15
50	x	58	x	4	x	7	58	56	4.15
55	x	63	x	4	x	7	63	61	4.15
56	x	64	x	4	x	7	64	62	4.15
60	x	68	x	4	x	7	68	66	4.15
63	x	71	x	4	x	7	71	69	4.15
65	x	73	x	4	x	7	73	71	4.15
70	x	78	x	4	x	7	78	76	4.15
80	x	88	x	4	x	7	88	86	4.15
90	x	98	x	4	x	7	98	96	4.15
100	x	108	x	4	x	7	108	106	4.15
110	x	122	x	5.5	x	10	122	119	5.65
120	x	132	x	5.5	x	10	132	129	5.65
125	x	137	x	5.5	x	10	137	134	5.65
130	x	142	x	5.5	x	10	142	139	5.65
140	x	152	x	5.5	x	10	152	149	5.65
160	x	172	x	5.5	x	10	172	169	5.65
180	x	192	x	5.5	x	10	192	189	5.65
200	x	212	x	5.5	x	10	212	209	5.65
220	x	235	x	6.5	x	13	235	231	6.65
240	x	255	x	6.5	x	13	255	241	6.65
250	x	265	x	6.5	x	13	265	261	6.65

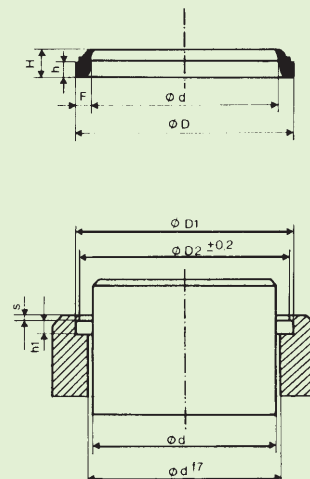



## **Inleiding**

De V-ring is een gummi elastische as- en lagerafdichting die tegen een tegenloopvlak wordt gemonteerd.

Het bijzondere van deze afdichting is de axiale dichtlip.

De dynamische afdichting vindt axiaal plaats en niet radiaal zoals bij de overige as-afdichtingen.

De V-ring wordt toegepast om een eenvoudige goed werkende afdichting te krijgen tegen o.a. water, vuil en stof.

De V-ring heeft een lage wrijving waardoor minder vermogensverlies optreedt.

Bij het toepassen van de V-ring hoeft men geen speciale kamer te draaien.

De V-ring dicht ook nog af als de as onrond is en exentrisch loopt. Eén bepaalde V-ring is voor meerdere asdiameters te gebruiken.

## **Materiaal**

De V-ring wordt uit een hoogslijtvast NBR rubber vervaardigd.

Daarnaast is de V-ring ook leverbaar in Viton®.

Veel zorg is besteedt aan de soepele manchet zodat de druk van de dichtlip tegen het loopvlak zeer laag is.

## **Montage**

De V-ring is eenvoudig te monteren. De V-ring wordt over de as getrokken en met behulp van bijvoorbeeld een schroevendraaier op zijn plaats gebracht.

## **Profielen**

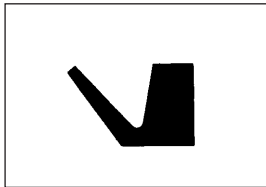

Type VA

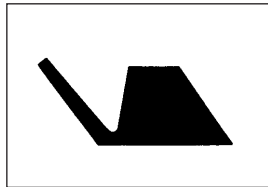

Type VS

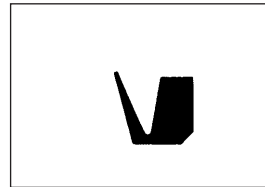

Type VL

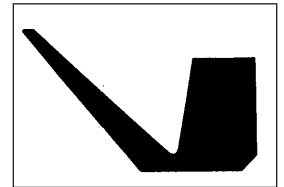

Type VE

## V-ringen type VS NBR - FPM

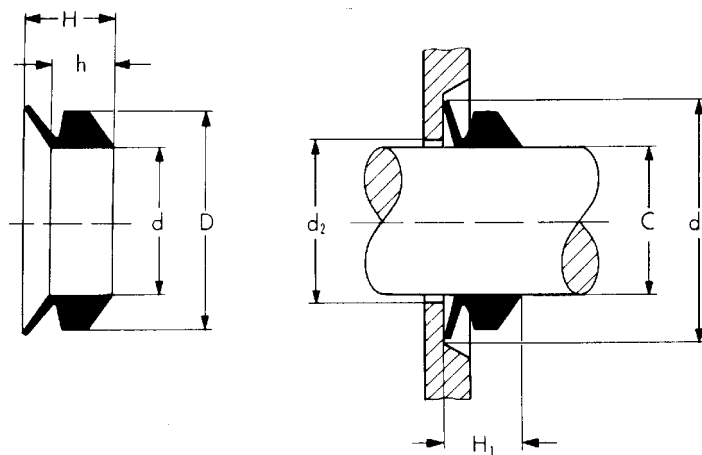

type VS	as bereik Ø	d	afmetingen		
			D	h	H
VS 5	4,5 - 5,5	4	8	3,9	5,2
VS 6	5,5 - 6,5	5	9	3,9	5,2
VS 7	6,5 - 8	6	10	3,9	5,2
VS 8	8 - 9,5	7	11	3,9	5,2
VS 10	9,5 - 11,5	9	15	5,6	7,7
VS 12	11,5 - 13,5	10,5	16,5	5,6	7,7
VS 14	13,5 - 15,5	12,5	18,5	5,6	7,7
VS 16	15,5 - 17,5	14	20	5,6	7,7
VS 18	17,5 - 19	16	22	5,6	7,7
VS 20	19 - 21	18	26	7,9	10,5
VS 22	21 - 24	20	28	7,9	10,5
VS 25	24 - 27	22	30	7,9	10,5
VS 28	27 - 29	25	33	7,9	10,5
VS 30	29 - 31	27	35	7,9	10,5
VS 32	31 - 33	29	37	7,9	10,5
VS 35	33 - 36	31	39	7,9	10,5
VS 38	36 - 38	34	42	7,9	10,5
VS 40	38 - 43	36	46	9,5	13
VS 45	43 - 48	40	50	9,5	13
VS 50	48 - 53	45	55	9,5	13
VS 55	53 - 58	49	59	9,5	13
VS 60	58 - 63	54	64	9,5	13
VS 65	63 - 68	58	68	9,5	13
VS 70	68 - 73	63	75	11,3	15,5
VS 75	73 - 78	67	79	11,3	15,5
VS 80	78 - 83	72	84	11,3	15,5
VS 85	83 - 88	76	88	11,3	15,5
VS 90	88 - 93	81	93	11,3	15,5
VS 95	93 - 98	85	97	11,3	15,5
VS 100	98 - 105	90	102	11,3	15,5
VS 110	105 - 115	99	113	13,1	18
VS 120	115 - 125	108	122	13,1	18
VS 130	125 - 135	117	131	13,1	18
VS 140	135 - 145	126	140	13,1	18
VS 150	145 - 155	135	149	13,1	18
VS 160	155 - 165	144	160	15	20,5
VS 170	165 - 175	153	169	15	20,5
VS 180	175 - 185	162	178	15	20,5
VS 190	185 - 195	171	187	15	20,5
VS 199	195 - 210	180	196	15	20,5

## V-ringen type VA NBR - FPM

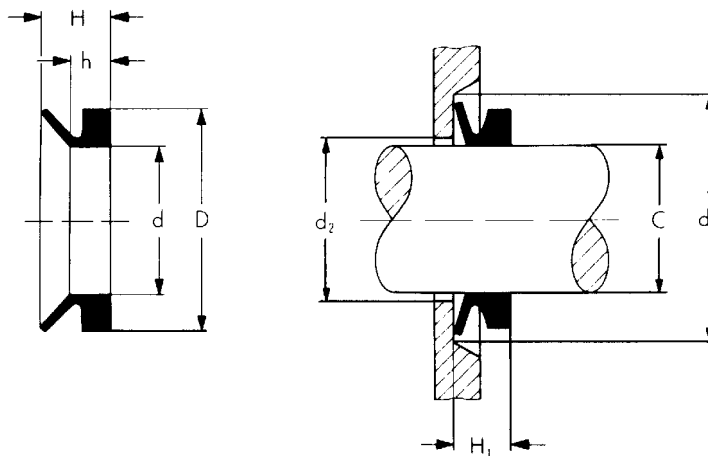

type VA	as bereik Ø	d	afmetingen			H
			D	h		
VA 3	2,7 - 3,5	2,5	5,5	2,1	3,7	
VA 4	3,5 - 4,5	3,2	7,2	2,4	3,7	
VA 5	4,5 - 5,5	4	8	2,4	3,7	
VA 6	5,5 - 6,5	5	9	2,4	3,7	
VA 7	6,5 - 8	6	10	2,4	3,7	
VA 8	8 - 9,5	7	11	2,4	3,7	
VA 10	9,5 - 11,5	9	15	3,4	5,5	
VA 12	11,5 - 13,5	10,5	16,5	3,4	5,5	
VA 14	13,5 - 15,5	12,5	18,5	3,4	5,5	
VA 16	15,5 - 17,5	14	20	3,4	5,5	
VA 18	17,5 - 19	16	22	3,4	5,5	
VA 20	19 - 21	18	26	4,7	7,5	
VA 22	21 - 24	20	28	4,7	7,5	
VA 25	24 - 27	22	30	4,7	7,5	
VA 28	27 - 29	25	33	4,7	7,5	
VA 30	29 - 31	27	35	4,7	7,5	
VA 32	31 - 33	29	37	4,7	7,5	
VA 35	33 - 36	31	39	4,7	7,5	
VA 38	36 - 38	34	42	4,7	7,5	
VA 40	38 - 43	36	46	5,5	9	
VA 45	43 - 48	40	50	5,5	9	
VA 50	48 - 53	45	55	5,5	9	
VA 55	53 - 58	49	59	5,5	9	
VA 60	58 - 63	54	64	5,5	9	
VA 65	63 - 68	58	68	5,5	9	
VA 70	68 - 73	63	75	6,8	11	
VA 75	73 - 78	67	79	6,8	11	
VA 80	78 - 83	72	84	6,8	11	
VA 85	83 - 88	76	88	6,8	11	
VA 90	88 - 93	81	93	6,8	11	
VA 95	93 - 98	85	97	6,8	11	
VA 100	98 - 105	90	102	6,8	11	
VA 110	105 - 115	99	113	7,9	12,8	
VA 120	115 - 125	108	122	7,9	12,8	
VA 130	125 - 135	117	131	7,9	12,8	
VA 140	135 - 145	126	140	7,9	12,8	
VA 150	145 - 155	135	149	7,9	12,8	
VA 160	155 - 165	144	160	9	14,5	
VA 170	165 - 175	153	169	9	14,5	
VA 180	175 - 185	162	178	9	14,5	
VA 190	185 - 195	171	187	9	14,5	
VA 199	195 - 210	180	196	9	14,5	
VA 200	190 - 210	180	210	14,3	25	
VA 220	210 - 235	198	228	14,3	25	
VA 250	235 - 265	225	255	14,3	25	

type VA	as bereik Ø	d	afmetingen			H
			D	h		
VA 275	265 - 290	247	277	14,3	25	
VA 300	290 - 310	270	300	14,3	25	
VA 325	310 - 335	292	322	14,3	25	
VA 350	335 - 365	315	345	14,3	25	
VA 375	365 - 390	337	367	14,3	25	
VA 400	390 - 430	360	390	14,3	25	
VA 450	430 - 480	405	435	14,3	25	
VA 500	480 - 530	450	480	14,3	25	
VA 550	530 - 580	495	525	14,3	25	
VA 600	580 - 630	540	570	14,3	25	
VA 650	630 - 665	600	630	14,3	25	
VA 700	665 - 705	630	660	14,3	25	
VA 725	705 - 745	670	700	14,3	25	
VA 750	745 - 785	705	735	14,3	25	
VA 800	785 - 830	745	775	14,3	25	
VA 850	830 - 875	785	815	14,3	25	
VA 900	875 - 920	825	855	14,3	25	
VA 950	920 - 965	865	895	14,3	25	
VA 1000	965 - 1015	910	940	14,3	25	
VA 1050	1015 - 1065	955	985	14,3	25	
VA 1100	1065 - 1115	1000	1030	14,3	25	
VA 1150	1115 - 1165	1045	1075	14,3	25	
VA 1200	1165 - 1215	1090	1120	14,3	25	
VA 1250	1215 - 1270	1135	1165	14,3	25	
VA 1300	1270 - 1320	1180	1210	14,3	25	
VA 1350	1320 - 1370	1225	1255	14,3	25	
VA 1400	1370 - 1420	1270	1300	14,3	25	
VA 1450	1420 - 1470	1315	1345	14,3	25	
VA 1500	1470 - 1520	1360	1390	14,3	25	
VA 1550	1520 - 1570	1405	1435	14,3	25	
VA 1600	1570 - 1620	1450	1480	14,3	25	
VA 1650	1620 - 1670	1495	1525	14,3	25	
VA 1700	1670 - 1720	1540	1570	14,3	25	
VA 1750	1720 - 1770	1585	1615	14,3	25	
VA 1800	1770 - 1820	1630	1660	14,3	25	
VA 1850	1820 - 1870	1675	1705	14,3	25	
VA 1900	1870 - 1920	1720	1750	14,3	25	
VA 1950	1920 - 1970	1765	1795	14,3	25	
VA 2000	1970 - 2020	1810	1840	14,3	25	

## V-ringen type VL NBR - FPM

Afmetingen:

H = 10.5

h = 6.0

W = 6.5

Montage maten:

H1 =  $8 \pm 1.5$

d2 max. = C + 5

d1 min. = C + 20

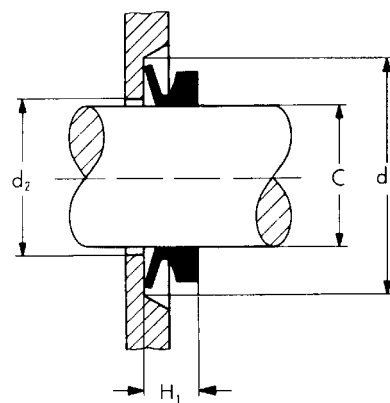
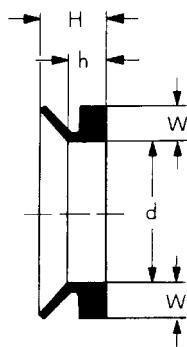

type VL	as bereik Ø	d	afmetingen		
			D	h	H
VL 140	135 - 145	126			
VL 150	145 - 155	135			
VL 160	155 - 165	144			
VL 170	165 - 175	153			
VL 180	175 - 185	162			
VL 190	185 - 195	171			
VL 200	195 - 210	182			
VL 220	210 - 233	198			
VL 250	233 - 260	225			
VL 275	260 - 285	247			
VL 300	285 - 310	270			
VL 325	310 - 335	292			
VL 350	335 - 365	315			
VL 375	365 - 385	337			
VL 400	385 - 410	360			
VL 425	410 - 440	382			
VL 450	440 - 475	405			
VL 500	480 - 530	450			
VL 550	530 - 580	485			
VL 600	580 - 630	540			

## V-ringen type VE NBR

Afmetingen:

H = 65

h = 32

W = 30

Montage maten:

H1 = 50 + 12

d2 max. = C + 24

d1 min. = C + 115

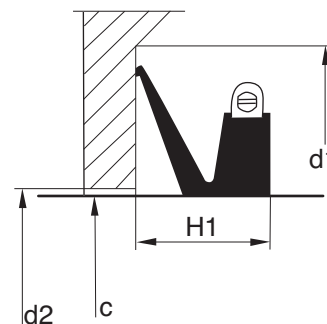
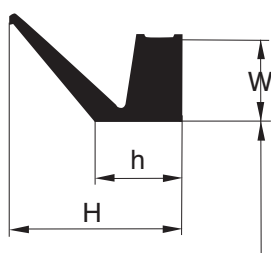

type	as bereik	d
VE 450	450 - 455	439
VE 455	455 - 460	444
VE 460	460 - 465	448
VE 465	465 - 470	453
VE 470	470 - 475	458
VE 475	475 - 480	463
VE 480	480 - 485	468
VE 485	485 - 490	473
VE 490	490 - 495	478
VE 495	495 - 500	483
VE 500	500 - 505	488
VE 505	505 - 510	493
VE 510	510 - 515	497
VE 515	515 - 520	502
VE 520	520 - 525	507
VE 525	525 - 530	512
VE 530	530 - 535	517
VE 535	535 - 540	521
VE 540	540 - 545	526
VE 545	545 - 550	531
VE 550	550 - 555	536
VE 555	555 - 560	541
VE 560	560 - 565	546
VE 565	565 - 570	550
VE 570	570 - 575	555
VE 575	575 - 580	560
VE 580	580 - 585	565
VE 585	585 - 590	570
VE 590	590 - 600	575
VE 600	600 - 610	582
VE 610	610 - 620	592
VE 620	620 - 630	602
VE 630	630 - 640	612
VE 640	640 - 650	621
VE 650	650 - 660	631
VE 660	660 - 670	640
VE 670	670 - 680	650
VE 680	680 - 690	660
VE 690	690 - 700	670
VE 700	700 - 710	680
VE 710	710 - 720	689
VE 720	720 - 730	699
VE 730	730 - 740	709
VE 740	740 - 750	718
VE 750	750 - 758	728

type	as bereik	d
VE 760	758 - 766	735
VE 770	766 - 774	743
VE 780	774 - 783	751
VE 790	783 - 792	759
VE 800	792 - 801	768
VE 810	801 - 810	777
VE 820	810 - 821	786
VE 830	821 - 831	796
VE 840	831 - 841	805
VE 850	842 - 851	814
VE 860	851 - 861	824
VE 870	861 - 871	833
VE 880	871 - 882	843
VE 890	882 - 892	853
VE 900	892 - 912	871
VE 920	912 - 922	880
VE 930	922 - 933	890
VE 940	933 - 944	900
VE 950	944 - 955	911
VE 960	955 - 966	921
VE 970	966 - 977	932
VE 980	977 - 988	942
VE 990	988 - 999	953
VE 1000	999 - 1010	963
VE 1020	1010 - 1025	973
VE 1040	1025 - 1045	990
VE 1060	1045 - 1065	1008
VE 1080	1065 - 1085	1027
VE 1100	1085 - 1105	1045
VE 1120	1105 - 1125	1065
VE 1140	1125 - 1145	1084
VE 1160	1145 - 1165	1103
VE 1180	1165 - 1185	1121
VE 1200	1185 - 1205	1139
VE 1220	1205 - 1225	1157
VE 1240	1225 - 1245	1176
VE 1260	1245 - 1270	1195
VE 1280	1270 - 1295	1218
VE 1300	1296 - 1315	1240
VE 1325	1315 - 1340	1259
VE 1350	1340 - 1365	1281
VE 1375	1365 - 1390	1305
VE 1400	1390 - 1415	1328
VE 1425	1415 - 1440	1350
VE 1450	1440 - 1465	1374

type	as bereik	d
VE 1475	1465 - 1490	1397
VE 1500	1490 - 1515	1419
VE 1525	1515 - 1540	1443
VE 1550	1540 - 1570	1467
VE 1575	1570 - 1600	1495
VE 1600	1600 - 1640	1524
VE 1650	1640 - 1680	1559
VE 1700	1680 - 1720	1596
VE 1750	1720 - 1765	1632
VE 1800	1765 - 1810	1671
VE 1850	1810 - 1855	1714
VE 1900	1855 - 1905	1753
VE 1950	1905 - 1955	1794
VE 2000	1955 - 2010	1844

## Usit-ringen

Usit-ringen ook wel Dowty-seals, Bonded-seals of Multi-seals genoemd, zijn zelfdichtende onderlegingen, opgebouwd uit een roestwerende metalen ring met een aan de binnenzijde ge vulcaniseerde manchet van synthetisch rubber die statisch afdichten.

Deze rubberkwaliteit op NBR-basis is goed olie en waterbestendig bij temperaturen van – 30°C tot +100°C.

De ring dicht van binnen naar buiten.

De Usit-ring kan worden toegepast als afdichting onder schroefdraadverbindingen en kleine flensverbindingen en is bestand tegen een zeer hoge werkdruk.

Afmetingen		
d	x D	x s
4,1	x 7,2	x 1
4,1	x 7,3	x 1
4,5	x 7	x 1
5,7	x 9	x 1
5,7	x 10	x 1
6,7	x 10	x 1
6,7	x 11	x 1
7,1	x 12	x 1
8,7	x 13	x 1
8,7	x 14	x 1
8,7	x 16	x 1
9,3	x 13,3	x 1
10,35	x 16	x 2
10,7	x 16	x 1,5
10,7	x 18	x 1,5
11,8	x 19,1	x 1,5
12,7	x 18	x 1,5
12,7	x 20	x 1,5
13,7	x 20,6	x 1,5
13,7	x 22	x 1,5
14	x 18,7	x 1,5
14,7	x 22	x 1,5
16,7	x 24	x 1,5
17,3	x 23,9	x 2,1
17,4	x 24	x 1,5
18,7	x 26	x 1,5
19,7	x 26,9	x 2,5
20,7	x 28	x 1,5
21,5	x 28,7	x 2,5
22,7	x 30	x 2

Afmetingen		
d	x D	x s
22,7	x 30	x 3
23,5	x 31,8	x 2,5
24,7	x 32	x 2
26,7	x 35	x 2
27	x 35	x 2,5
27,2	x 36	x 2
28,3	x 36,6	x 2,5
28,7	x 37	x 2
29,3	x 36,6	x 2,5
31	x 39	x 2
32,6	x 41,4	x 3,4
33,7	x 42	x 2
33,9	x 42,8	x 3,4
34,3	x 43	x 2
36,7	x 46	x 2
39	x 47,8	x 3,4
42,7	x 53	x 3
42,9	x 52,4	x 3,4
48,7	x 59	x 3
51,7	x 63,5	x 3,4
53,3	x 64,5	x 3
60,7	x 73	x 3
76,1	x 90,2	x 3,4

## Usit assortiment

10 4,5x7x1	10 5,7x10x1	10 6,7x11x1	10 7,1x12x1	10 8,7x13x1	10 8,7x14x1
10 8,7x16x1	10 10,7x16x1,5	10 10,7x18x1,5	10 12,7x20x1,5	10 13,7x22x1,5	10 14,7x22x1,5
10 16,7x24x1,5	10 17,4x24x1,5	10 18,7x26x1,5	5 20,7x28x1,5	5 22,7x30x3	5 24,7x32x2
5 26,7x35x2	5 28,7x37x3	5 31x39x2	5 34,3x43x2	5 36,7x46x2	5 42,7x53x3

## Eindkappen A-EC

Eindkappen zijn statische dichtingen die worden gebruikt als afdichting van lagers bij een aseind.  
 De eindkap bestaat uit een ongelegeerde koolstofstalen versterkingsring met daarom heen een gevulkaniseerde buitenmantel.  
 De eindkap is ontworpen ter vervanging van de veel gebruikte schroefdeksel.  
 Montage- en constructiekosten worden door toepassing van een eindkap sterk gereduceerd.  
 Bij gebruik van een eindkap wordt de eindopening bij assen grondig afgedicht.  
 De huispassing voor de eindkap is gelijk aan die van de oliekeerringen, n.l. H8.

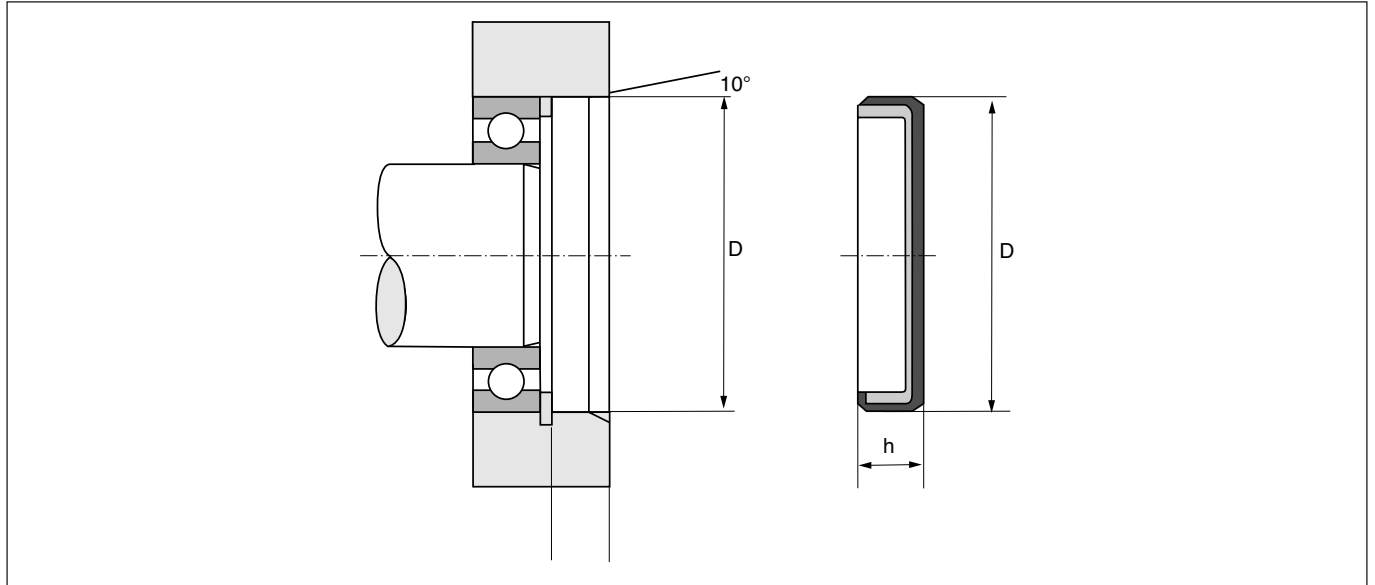

materiaal ring : ongelegeerd koolstofstaal  
 materiaal mantel : NBR 70 shore

STEFA type VK

D = buitendiameter  
 h = hoogte

D		h	D		h	D		h
21	x	4	45	x	9.5	85	x	12
22	x	7	47	x	7	90	x	8
24	x	7	47	x	10	90	x	12
26	x	6.5	50	x	10	95	x	10
28	x	7	52	x	7	100	x	12
30	x	8	52	x	10	110	x	12
32	x	7	55	x	10	120	x	12
32	x	9.5	62	x	7	125	x	12
35	x	7	62	x	8	130	x	12
35	x	8	65	x	10	140	x	15
37	x	5	68	x	8	150	x	15
37	x	10	72	x	9	160	x	15
40	x	7	75	x	12	170	x	15
42	x	7	80	x	10	180	x	13
42	x	9.5	80	x	12	200	x	13

## Gamma ringen

Gamma ringen zijn radiaal afdichtingen die worden gebruikt als vuilafdichting bij roterende assen (lagerblokken e.d.).

De Gamma ring bestaat uit een geanodiseerde koolstofstalen buitenmantel met daarin een soort rubber V-ring die wordt opgesloten door een felsrand. De rubber ring zit dus niet aan de buitenmantel ge vulkaniseerd.

De Gamma ring is eenvoudig te monteren en blijft door zijn passing h9 goed op zijn plaats.

Voor de Gamma ring type 9 RB dient in het af te dichten huis een groef te worden gestoken om de ring te monteren.

De Gamma ring 9 RB heeft hierdoor nog een betere afdichting tegen vuil van buitenaf.

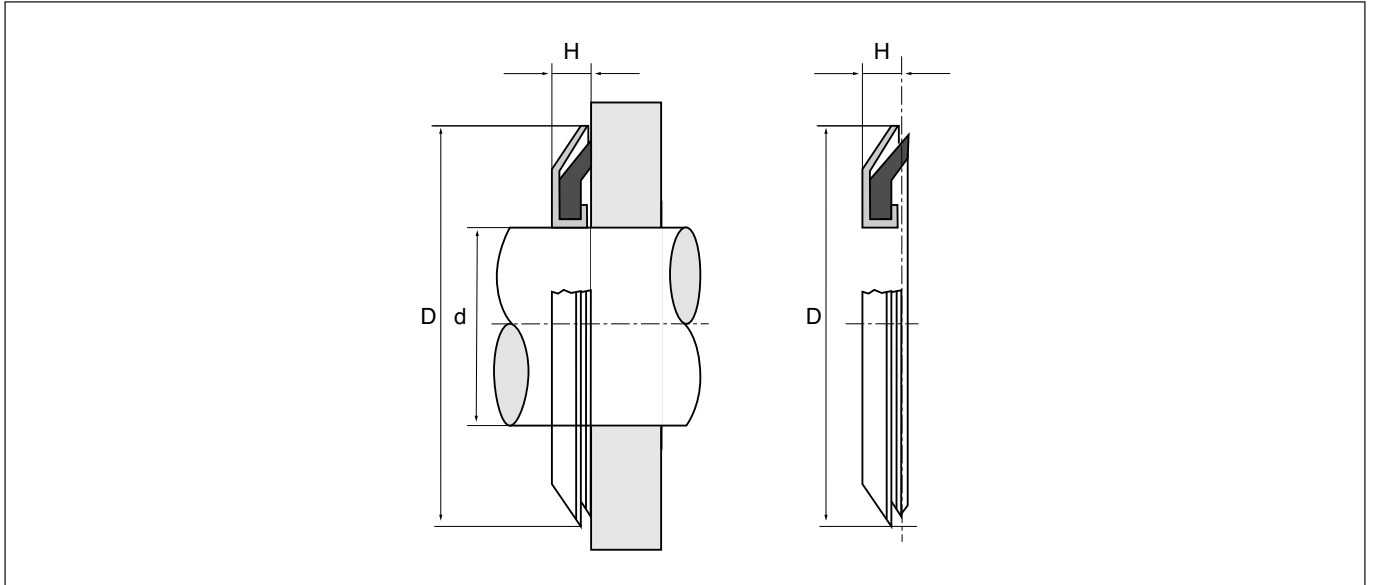

materiaal ring : geanodiseerd koolstofstaal  
 materiaal dichting : NBR 70 shore

**STEFA type RB**

d = binnendiameter  
 D = buitendiameter  
 H = hoogte

d	D	H	d	D	H
10	24	3.5	53	73	5.5
12	26	3.5	55	75	5.5
15	30	4	58	78	5.5
16	32	7	60	80	5.5
17	32	4	62	82	5.5
18	33	4	65	85	5.5
20	35	4	68	88	5.5
22	40	4	70	90	5.5
24	40	4	72	92	5.5
25	40	4	75	95	5.5
26	40	4	78	98	5.5
28	43	4	80	100	5.5
30	47	4.5	85	105	5.5
32	49	4.5	90	110	5.5
35	52	4.5	95	115	5.5
40	57	4.5	100	120	5.5
45	62	4.5	105	125	5.5
48	65	4.5	125	148	6.5
50	70	5.5	135	159	6.5
52	72	5.5			



# Gamma ringen

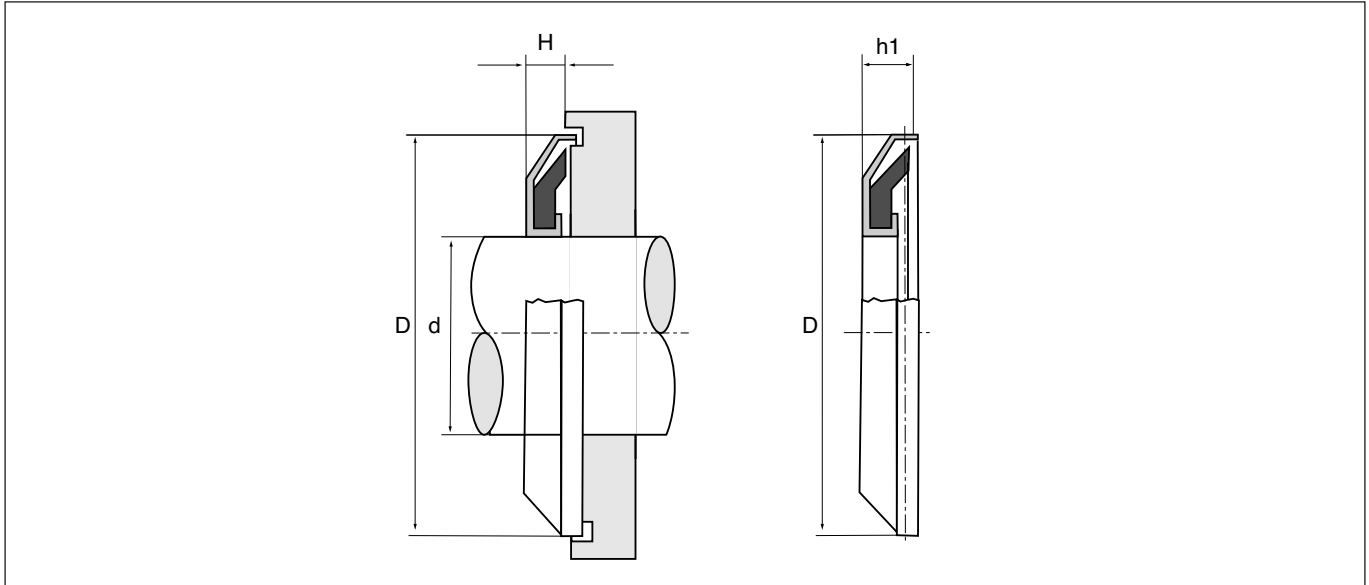

STEFA type 9 RB

- d = binnendiameter
- D = buitendiameter
- H = hoogte
- h1 = totale hoogte 9 RB

d	D	H	h1	d	D	H	h1
15	32	4	6	60	82	5.5	7.5
17	34	4	6	65	87	5.5	7.5
20	37	4	6	70	92	5.5	7.5
25	42	4	6	80	102	5.5	7.5
30	48	4.5	6.5	85	107	5.5	7.5
35	53	4.5	6.5	90	112	5.5	7.5
40	58	4.5	6.5	95	117	5.5	7.5
50	72	5.5	7.5	100	122	5.5	7.5
55	77	5.5	7.5				

## CR Speedi Sleeves

Een oliekeerring dicht alleen goed af als het loopvlak op de as voldoet aan bijzonder hoge eisen. Zo mag dit oppervlak niet te glad of te ruw zijn, mag geen bewerkingsporen of mechanische beschadigingen vertonen en dient geheel vrij te zijn van corrosie. Een Speedi-Sleeve is een roestvaststalen (staal 304) huls met een loopvlak dat voldoet aan de allerhoogste eisen.

Zodoende is de Speedi-Sleeve een onderdeel dat bij een nieuwe as kosten bespaart, omdat aan de as zelf veel minder eisen gesteld behoeven te worden.

Bij vervanging van een oliekeering die direct op een as liep, blijkt in de regel dat de keerring de as heeft beschadigd.

Hier is de Speedi-Sleeve ideaal, aangezien het niet noodzakelijk is de oude as te vervangen of te repareren omdat een Speedi-Sleeve, over de as heengeschoven, een nieuw perfect loopvlak biedt. De wanddikte van de sleeve is extreem dun, zodat een nieuwe keerring met dezelfde maat gemonteerd kan worden. In de praktijk is gebleken dat het oppervlak van een Speedi-Sleeve zulke uitstekende eigenschappen heeft dat ze veel langer meegaat dan gewoonlijk gebruikte asmaterialen en dat hierdoor op onderhoud kan worden bespaard.

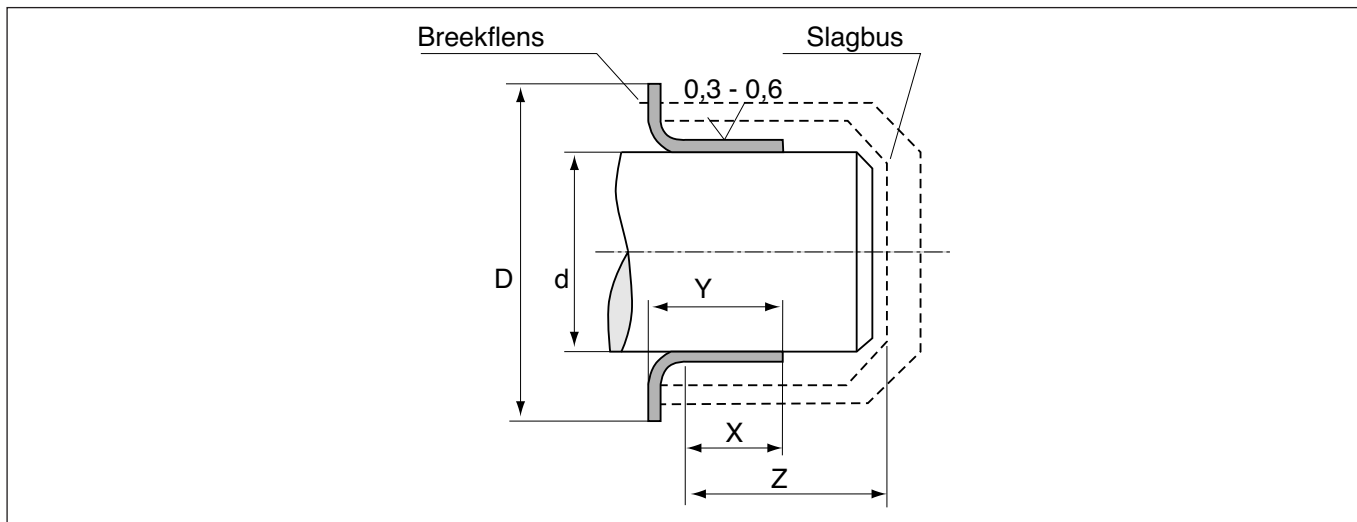

### Montage

Speedi-Sleeves zijn per stuk verpakt in een doosje.

Een montagebus, die de sleeve tijdens transport beschermt, is mee verpakt evenals een foldertje met duidelijke montage-instructies.

De Speedi-Sleeve is voorzien van een montageflens die, indien gewenst, na montage eenvoudig verwijderd kan worden.

Codering	As-diam.	Breedte in mm
99.050	12,70	6,35
99.059	15,00	5,00
99.062	15,87	8,00
99.068	17,00	8,00
99.082	18,00	8,00
99.076	19,05	8,00
99.078	20,00	8,00
99.085	22,00	8,00
99.087	22,22	8,00
99.098	25,00	8,00
99.100	25,40	8,00
99.106	27,00	8,00
99.111	28,00	9,50
99.112	28,57	8,00
99.114	30,00	8,00
99.125	31,75	8,00
99.128	32,00	8,00
99.138	34,92	12,70
99.139	35,00	13,00
99.149	38,10	14,30
99.157	40,00	13,00
99.162	41,27	14,30
99.169	42,00	14,30
99.171	43,65	14,30
99.174	44,45	14,30

Codering	As-diam.	Breedte in mm
99.177	45,00	14,00
99.181	46,04	14,30
99.187	47,62	14,30
99.189	48,00	14,00
99.196	50,00	14,00
99.199	50,80	14,30
99.205	52,38	19,90
99.210	53,97	12,70
99.212	54,00	19,90
99.215	55,00	20,00
99.225	57,15	19,90
99.235	60,00	20,00
99.237	60,32	19,90
99.243	62,00	19,90
99.250	63,50	19,90
99.254	65,00	20,00
99.263	66,75	19,90
99.275	69,85	19,90
99.276	70,00	20,00
99.293	74,60	19,90
99.294	75,00	19,90
99.300	76,20	20,60
99.312	79,38	19,90
99.315	80,00	20,00
99.328	82,00	15,50

Codering	As-diam.	Breedte in mm
99.326	82,55	17,50
99.331	84,00	19,90
99.333	85,00	21,00
99.337	85,72	19,90
99.350	88,90	20,60
99.354	90,00	23,00
99.362	92,08	20,60
99.369	95,00	21,00
99.372	95,25	17,50
99.393	100,00	20,60
99.399	101,60	20,60
99.413	105,00	20,00
99.424	107,95	20,60
99.435	110,00	12,90
99.450	114,30	20,60
99.452	115,00	20,60
99.473	120,00	20,00
99.475	120,65	12,70
99.492	125,00	26,00
99.499	127,00	20,60
99.494	130,00	19,00
99.525	133,35	20,60
99.533	135,00	20,60
99.537	136,52	20,60
99.552	140,00	20,00

Codering	As-diam.	Breedte in mm
99.595	150,00	26,00
99.599	152,40	25,40
99.605	154,00	26,00
99.606	155,00	26,00
99.625	158,75	26,00
99.630	160,00	25,40
99.650	165,10	25,40
99.640	170,00	31,80
99.675	171,45	20,60
99.687	175,00	28,00
99.700	177,80	25,40
99.721	180,00	33,00
99.787	200,00	34,50

---

## **Borgringen - SEEGER ringen**

Borgringen, ook wel borgveren, circlips, veerringen genoemd, zijn in principe bedoeld om onderdelen axiaal op een as of in een buisboring te fixeren.

De belangrijkste types zijn exentrisch gevormd en worden verend in een groef gemonteerd.

Borgringen zijn geschikt om axiale krachten op te nemen.

De meest voorkomende borgringen zijn volgens DIN 471 (as), DIN 472 (buis), DIN 6799 (as).

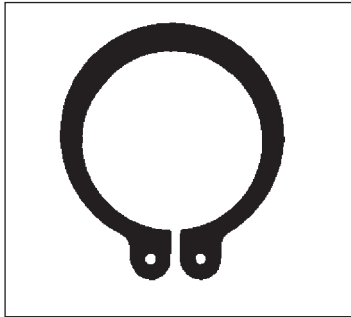

**DIN 471**



**DIN 472**



**DIN 6799**

De borgringen worden vervaardigd uit een hoogwaardig veren staal, gefosfateerd en geolied.  
Borgringen zijn ook leverbaar in roestvrij staal, materiaal X35CRM01.

## Borgringen DIN 471 voor Assen

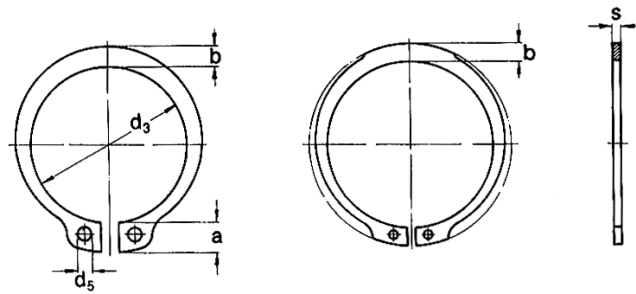

Type	s	d3	Type	s	d3	Type	s	d3	Type	s	d3
A 3	0,40	2,7	A 50	2,00	45,8	A 135	4,00	128,0	A 225	5,00	213,0
A 4	0,40	3,7	A 52	2,00	47,8	A 137	4,00	130,0	A 227	5,00	213,0
A 5	0,60	4,7	A 54	2,00	49,8	A 138	4,00	130,0	A 228	5,00	213,0
A 6	0,70	5,6	A 55	2,00	50,8	A 140	4,00	133,0	A 230	5,00	218,0
A 7	0,80	6,5	A 56	2,00	51,8	A 142	4,00	135,0	A 232	5,00	218,0
A 8	0,80	7,4	A 57	2,00	52,8	A 145	4,00	138,0	A 235	5,00	223,0
A 9	1,00	8,4	A 58	2,00	53,8	A 147	4,00	140,0	A 237	5,00	223,0
A 10	1,00	9,3	A 60	2,00	55,8	A 148	4,00	140,0	A 238	5,00	223,0
A 11	1,00	10,2	A 62	2,00	57,8	A 150	4,00	142,0	A 240	5,00	228,0
A 12	1,00	11,0	A 63	2,00	58,8	A 152	4,00	143,0	A 242	5,00	228,0
A 13	1,00	11,9	A 65	2,50	60,8	A 155	4,00	146,0	A 245	5,00	233,0
A 14	1,00	12,9	A 67	2,50	62,5	A 157	4,00	148,0	A 247	5,00	233,0
A 15	1,00	13,8	A 68	2,50	63,5	A 158	4,00	148,0	A 248	5,00	233,0
A 16	1,00	14,7	A 70	2,50	65,5	A 160	4,00	151,0	A 250	5,00	238,0
A 17	1,00	15,7	A 72	2,50	67,5	A 162	4,00	152,5	A 252	5,00	238,0
A 18	1,20	16,5	A 75	2,50	70,5	A 165	4,00	155,5	A 255	5,00	240,0
A 19	1,20	17,5	A 77	2,50	72,5	A 167	4,00	157,5	A 257	5,00	240,0
A 20	1,20	18,5	A 78	2,50	73,5	A 168	4,00	157,5	A 258	5,00	240,0
A 21	1,20	19,5	A 80	2,50	74,5	A 170	4,00	160,5	A 260	5,00	245,0
A 22	1,20	20,5	A 82	2,50	76,5	A 172	4,00	160,5	A 262	5,00	245,0
A 23	1,20	21,5	A 85	3,00	79,5	A 175	4,00	165,5	A 265	5,00	250,0
A 24	1,20	22,2	A 87	3,00	81,5	A 177	4,00	167,5	A 267	5,00	250,0
A 25	1,20	23,2	A 88	3,00	82,5	A 178	4,00	167,5	A 268	5,00	250,0
A 26	1,20	24,2	A 90	3,00	84,5	A 180	4,00	170,5	A 270	5,00	255,0
A 27	1,20	24,9	A 92	3,00	86,5	A 182	4,00	170,5	A 272	5,00	255,0
A 28	1,50	25,9	A 95	3,00	89,5	A 185	4,00	175,5	A 275	5,00	260,0
A 29	1,50	26,9	A 97	3,00	91,5	A 187	4,00	177,5	A 277	5,00	260,0
A 30	1,50	27,9	A 98	3,00	91,5	A 188	4,00	177,5	A 278	5,00	260,0
A 31	1,50	28,6	A 100	3,00	94,5	A 190	4,00	180,5	A 280	5,00	265,0
A 32	1,50	29,6	A 102	4,00	95,0	A 192	4,00	180,5	A 282	5,00	265,0
A 33	1,50	30,5	A 105	4,00	96,0	A 195	4,00	185,5	A 285	5,00	270,0
A 34	1,50	31,5	A 107	4,00	100,0	A 197	4,00	187,5	A 287	5,00	270,0
A 35	1,50	32,2	A 108	4,00	100,0	A 198	4,00	187,5	A 288	5,00	270,0
A 36	1,75	33,2	A 110	4,00	103,0	A 200	4,00	190,5	A 290	5,00	275,0
A 37	1,75	34,2	A 112	4,00	105,0	A 202	5,00	190,0	A 292	5,00	275,0
A 38	1,75	35,2	A 115	4,00	108,0	A 205	5,00	193,0	A 295	5,00	280,0
A 39	1,75	36,0	A 117	4,00	110,0	A 207	5,00	193,0	A 297	5,00	280,0
A 40	1,75	36,5	A 118	4,00	110,0	A 208	5,00	193,0	A 298	5,00	280,0
A 41	1,75	37,5	A 120	4,00	113,0	A 210	5,00	198,0	A 300	5,00	285,0
A 42	1,75	38,5	A 122	4,00	115,0	A 212	5,00	198,0	A 305	6,00	288,0
A 44	1,75	40,5	A 125	4,00	118,0	A 215	5,00	203,0			
A 45	1,75	41,5	A 127	4,00	120,0	A 217	5,00	203,0			
A 46	1,75	42,5	A 128	4,00	120,0	A 218	5,00	203,0			
A 47	1,75	43,5	A 130	4,00	123,0	A 220	5,00	208,0			
A 48	1,75	44,5	A 132	4,00	125,0	A 222	5,00	208,0			

## Borringen DIN 472 voor Boringen

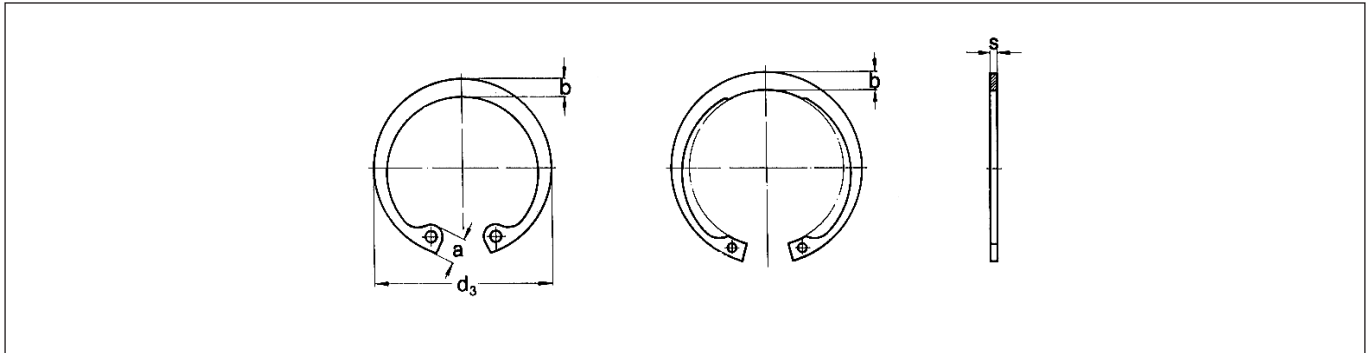

Type	s	d3	Type	s	d3	Type	s	d3	Type	s	d3
J 8	0,80	8,7	J 54	2,00	58,2	J 132	4,00	139,0	J 222	5,00	232,0
J 9	0,80	9,8	J 55	2,00	59,2	J 135	4,00	142,0	J 225	5,00	237,0
J 10	1,00	10,8	J 56	2,00	60,2	J 137	4,00	145,0	J 227	5,00	237,0
J 11	1,00	11,8	J 57	2,00	61,2	J 138	4,00	145,0	J 228	5,00	242,0
J 12	1,00	13,0	J 58	2,00	62,2	J 140	4,00	147,0	J 230	5,00	242,0
J 13	1,00	14,1	J 60	2,00	64,2	J 142	4,00	149,0	J 232	5,00	242,0
J 14	1,00	15,1	J 62	2,00	66,2	J 145	4,00	152,0	J 235	5,00	247,0
J 15	1,00	16,2	J 63	2,00	67,2	J 147	4,00	155,0	J 237	5,00	247,0
J 16	1,00	17,3	J 64	2,00	68,2	J 148	4,00	155,0	J 238	5,00	252,0
J 17	1,00	18,3	J 65	2,50	69,2	J 150	4,00	158,0	J 240	5,00	252,0
J 18	1,00	19,5	J 67	2,50	71,5	J 152	4,00	161,0	J 242	5,00	252,0
J 19	1,00	20,5	J 68	2,50	72,5	J 155	4,00	164,0	J 245	5,00	257,0
J 20	1,00	21,5	J 70	2,50	74,5	J 157	4,00	167,0	J 247	5,00	257,0
J 21	1,00	22,5	J 72	2,50	76,5	J 158	4,00	167,0	J 248	5,00	262,0
J 22	1,00	23,5	J 75	2,50	79,5	J 160	4,00	169,0	J 250	5,00	262,0
J 23	1,20	24,6	J 77	2,50	82,5	J 162	4,00	171,5	J 252	5,00	262,0
J 24	1,20	25,9	J 78	2,50	82,5	J 165	4,00	174,5	J 255	5,00	270,0
J 25	1,20	26,9	J 80	2,50	85,5	J 167	4,00	177,5	J 257	5,00	270,0
J 26	1,20	27,9	J 81	2,50	86,5	J 168	4,00	177,5	J 258	5,00	275,0
J 27	1,20	29,1	J 82	2,50	87,5	J 170	4,00	179,5	J 260	5,00	275,0
J 28	1,20	30,1	J 83	2,50	88,5	J 172	4,00	181,5	J 262	5,00	275,0
J 29	1,20	31,1	J 85	3,00	90,5	J 175	4,00	184,5	J 265	5,00	280,0
J 30	1,20	32,1	J 87	3,00	93,5	J 177	4,00	187,5	J 267	5,00	280,0
J 31	1,20	33,4	J 88	3,00	93,5	J 178	4,00	187,5	J 268	5,00	285,0
J 32	1,20	34,4	J 90	3,00	95,5	J 180	4,00	189,5	J 270	5,00	285,0
J 33	1,20	35,5	J 92	3,00	97,5	J 182	4,00	191,5	J 272	5,00	285,0
J 34	1,50	36,5	J 95	3,00	100,5	J 185	4,00	194,5	J 275	5,00	290,0
J 35	1,50	37,8	J 97	3,00	103,5	J 187	4,00	197,5	J 277	5,00	290,0
J 36	1,50	38,8	J 98	3,00	103,5	J 188	4,00	197,5	J 278	5,00	295,0
J 37	1,50	39,8	J 100	3,00	105,5	J 190	4,00	199,5	J 280	5,00	295,0
J 38	1,50	40,8	J 102	4,00	108,0	J 192	4,00	201,5	J 282	5,00	295,0
J 39	1,50	42,0	J 105	4,00	112,0	J 195	4,00	204,5	J 285	5,00	300,0
J 40	1,75	43,5	J 107	4,00	115,0	J 197	4,00	207,5	J 287	5,00	300,0
J 41	1,75	44,5	J 108	4,00	115,0	J 198	4,00	207,5	J 288	5,00	305,0
J 42	1,75	45,5	J 110	4,00	117,0	J 200	4,00	209,5	J 290	5,00	305,0
J 43	1,75	46,5	J 112	4,00	119,0	J 202	5,00	214,0	J 292	5,00	305,0
J 44	1,75	47,5	J 115	4,00	122,0	J 205	5,00	217,0	J 295	5,00	310,0
J 45	1,75	48,5	J 117	4,00	125,0	J 207	5,00	217,0	J 297	5,00	310,0
J 46	1,75	49,5	J 118	4,00	125,0	J 208	5,00	222,0	J 298	5,00	315,0
J 47	1,75	50,5	J 120	4,00	127,0	J 210	5,00	222,0	J 300	5,00	315,0
J 48	1,75	51,5	J 122	4,00	129,0	J 212	5,00	222,0			
J 50	2,00	54,2	J 125	4,00	132,0	J 215	5,00	227,0			
J 51	2,00	55,2	J 127	4,00	135,0	J 217	5,00	227,0			
J 52	2,00	56,2	J 128	4,00	135,0	J 218	5,00	232,0			
J 53	2,00	57,2	J 130	4,00	137,0	J 220	5,00	232,0			

## As Borgringen DIN 6799 + DIN 471 - DIN 472 uit roestvrij staal

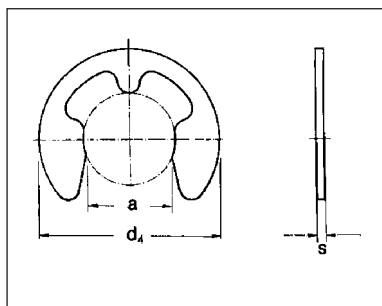

DIN 6799

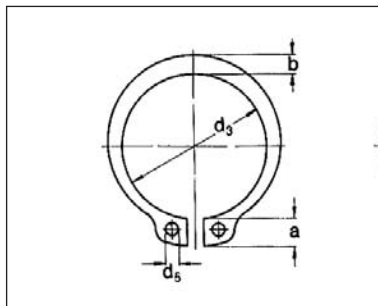

DIN 471

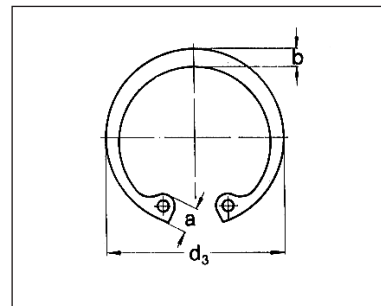

DIN 472

Type	s	d1 (van - tot)
RA 1,2	0,3	1,4 - 2,0
RA 1,5	0,4	2,0 - 2,5
RA 1,9	0,5	2,5 - 3,0
RA 2,3	0,6	3,0 - 4,0
RA 3,2	0,6	4,0 - 5,0
RA 4,0	0,7	5,0 - 7,0
RA 5,0	0,7	6,0 - 8,0
RA 6,0	0,7	7,0 - 9,0
RA 7,0	0,9	8,0 - 11,0
RA 8,0	1,0	9,0 - 12,0
RA 9,0	1,1	10,0 - 14,0
RA 10,0	1,2	11,0 - 15,0
RA 12,0	1,3	13,0 - 18,0
RA 15,0	1,5	16,0 - 24,0
RA 19,0	1,75	20,0 - 31,0
RA 24,0	2,0	25,0 - 38,0

Type	s	d3
A 5	0,6	4,7
A 6	0,7	5,6
A 7	0,8	6,5
A 8	0,8	7,4
A 9	1,0	8,4
A10	1,0	9,3
A11	1,0	10,2
A12	1,0	11,0
A13	1,0	11,9
A14	1,0	12,9
A15	1,0	13,8
A16	1,0	14,7
A17	1,0	15,7
A18	1,2	16,5
A19	1,2	17,5
A20	1,2	18,5
A22	1,2	20,5
A24	1,2	22,2
A25	1,2	23,2
A26	1,2	24,2
A27	1,2	24,9
A28	1,5	25,9
A29	1,5	26,9
A30	1,5	27,9
A32	1,5	29,6
A34	1,5	31,5
A35	1,5	32,2
A38	1,75	35,2
A40	1,75	36,5
A42	1,75	38,5
A45	1,75	41,5
A50	2,0	45,8
A55	2,0	50,8
A60	2,0	55,8
A65	2,5	60,8
A70	2,5	65,5
A80	2,5	74,5
A90	3,0	84,5

Type	s	d3
J 8	0,8	8,7
J 9	0,8	9,8
J10	1,0	10,8
J11	1,0	11,8
J12	1,0	13,0
J13	1,0	14,1
J14	1,0	15,1
J15	1,0	16,2
J16	1,0	17,3
J17	1,0	18,3
J18	1,0	19,5
J19	1,0	20,5
J20	1,0	21,5
J22	1,0	23,5
J23	1,2	24,6
J24	1,2	25,9
J25	1,2	26,9
J26	1,2	27,9
J28	1,2	30,1
J30	1,2	32,1
J32	1,2	34,4
J33	1,2	35,5
J34	1,5	36,5
J35	1,5	37,8
J36	1,5	38,8
J37	1,5	39,8
J38	1,5	40,8
J40	1,75	43,5
J42	1,75	45,5
J45	1,75	48,5
J47	1,75	50,5
J48	1,75	51,5
J50	2,0	54,2
J52	2,0	56,2
J55	2,0	59,2
J58	2,0	62,2
J60	2,0	64,2
J62	2,0	66,2
J65	2,5	69,2
J68	2,5	72,5
J70	2,5	74,5
J72	2,5	76,5
J75	2,5	79,5
J80	2,5	85,5
J85	3,0	90,5
J90	3,0	95,5

## NILOS-ringen

Nilos ringen zijn in de gehele wereld bekend als eenvoudige en ruimte besparende afdichting voor antifrictie lagers. Het juiste type nilos-ring op de juiste plaats, zorgt naast een verbetering ook voor een kostenbesparing bij de constructie.

Nilos-ringen zijn beschikbaar in twee standaard types. Het type met de dichtlip die aansluit op de buitenring van het lager; type AV. En het type met de dichtlip aansluitend aan de binnenring van het lager; type JV.

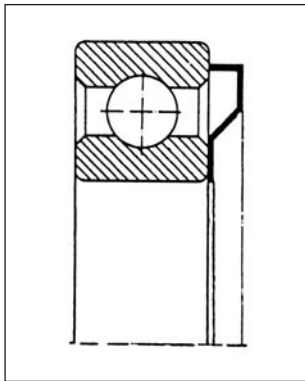

AV

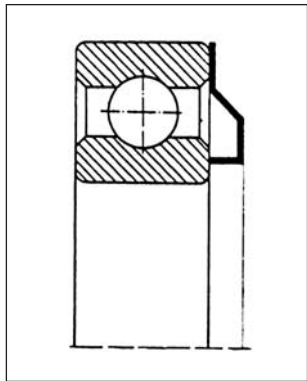

JV

Nilos-ringen zijn ook leverbaar voor lagers die reeds van een dubbele afdichting zijn voorzien.

Aansluitend op de buitenring; type ZAV

Aansluitend op de binnenring; type ZJV

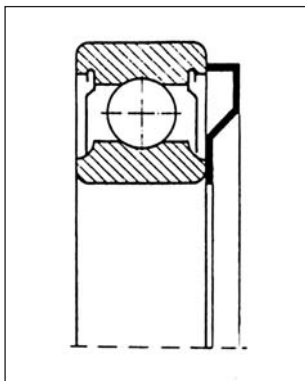



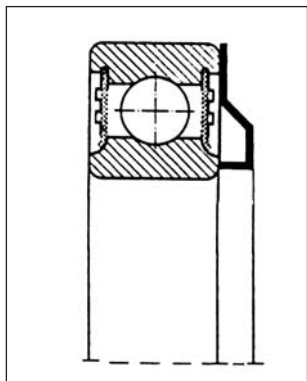







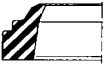







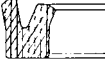

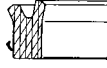



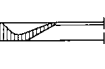



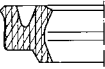
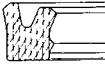
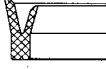
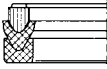

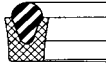

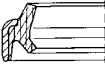

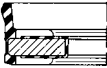

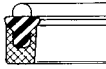





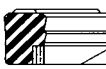
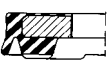



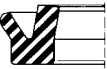

ZAV



ZJV

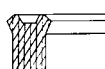

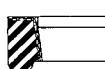

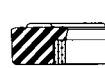
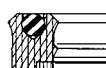







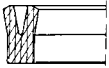
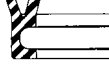



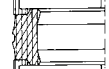

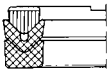
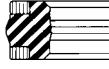
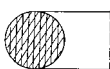

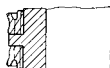
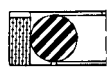

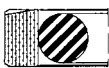

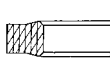
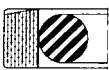
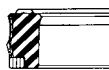

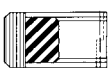

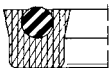

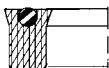
Neem voor meer informatie over Nilos-ringen contact op met onze afdeling verkoop.

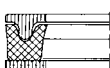
**Parker - Prädifa**

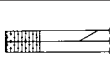

	A1		B1		L1		B5
	A2		B2		M2		B6
	A5		B3		M3		B7
	A6		BA		M5		C2
	A7		BD		M0		C4*
	AY		BS		N3		D1*
	AM		C1		Q1		DK
	AH		C3*		Q2		EK
			E1		Q3		DL
			E5		Q9		DP
			E8		R3		DE*
			E9*		RB		E2
			EL		ZE*		E4
			EP		ZG*		E6
			EV'		ZH*		G1
			GC		ZJ*		G2
			H1		ZR*		G5
			JA		ZU*		

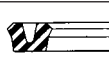





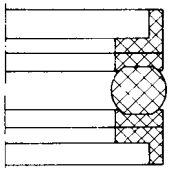
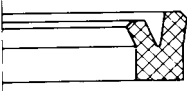
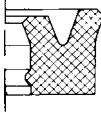
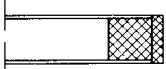
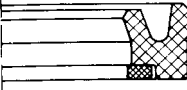
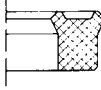
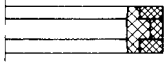
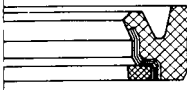
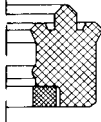
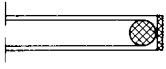

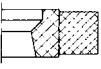
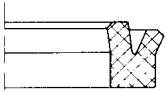
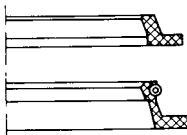
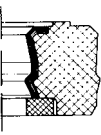
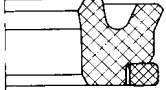
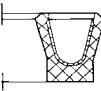
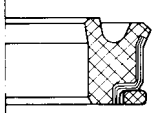
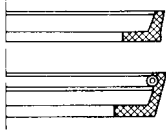



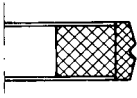
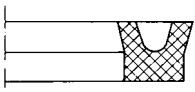

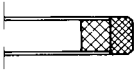
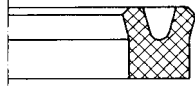

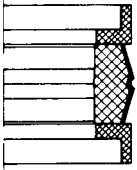
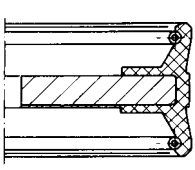
## Parker - Prädifa

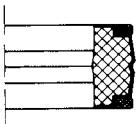
	G6		Z6*		K9
	GD		Z7		KA
	H2		Z8		
	KU		Z0*		
	M4		ZA*		V1(PU)
	OA		ZB*		KS
	OB*		ZC*		V2
	OE		ZD*		OV
	OH/OJ*		ZK*		V6
	OK		ZP*		PP
	SA		ZQ*		T2
	TA		ZS		W1
	TK*		ZX		YE
	Z1		ZY*		
	Z2				
	Z4				
	Z5				

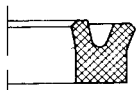

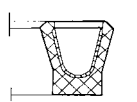

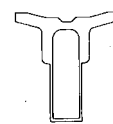
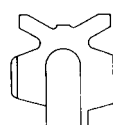

**Freudenberg - Simrit (cfw)**

	SIMKO		NI 150		NI 300
	TESKO		NI 250		KI 310
	TESKO-H		NI 400		KI 320
	TFMA		TFMI		KI 350
	NA 150		H		KI 520
	NA 250				FOI
	NA 400				
	T				

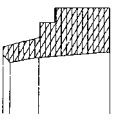
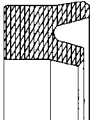
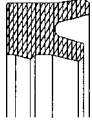
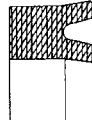
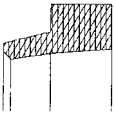
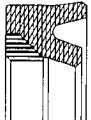
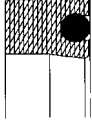
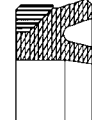
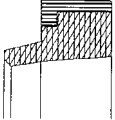
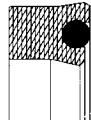
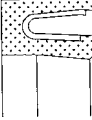
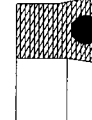
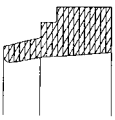
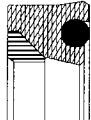
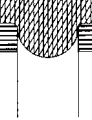
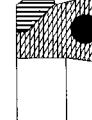
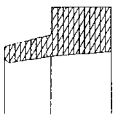
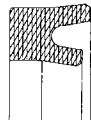
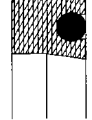
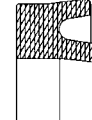
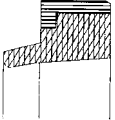

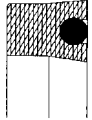

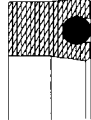
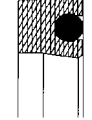
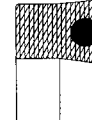
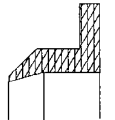
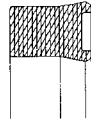
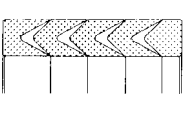
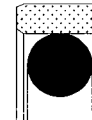
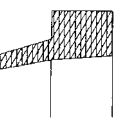
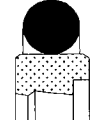
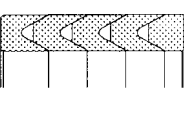
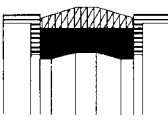
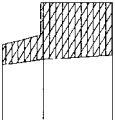
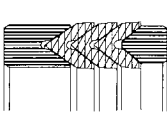
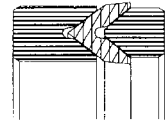
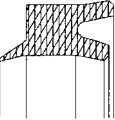
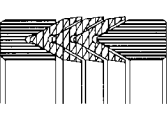
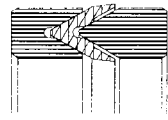
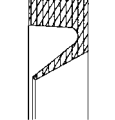
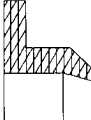





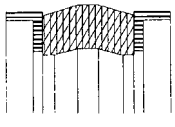
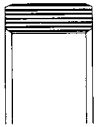

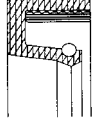
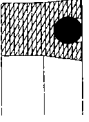

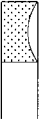
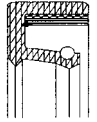
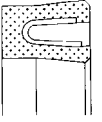

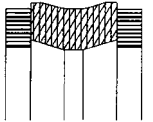
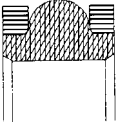
## Freudenberg - Simrit (cfw)

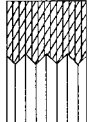
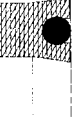
	SIMKO 300		NI		AUNI PSL
	TESKO 300		NI 100		NiPSL
	SIMKO 320		T-DUO		NIPSL SF
	SIMKO 520				NAP 300
	NA 300				NAP 310
	FOA				NAPN
					T-Duo P
					NA-Duo P
					PNEUKO

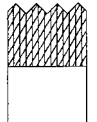
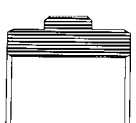

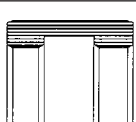

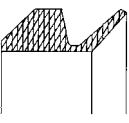

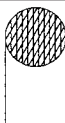



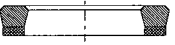

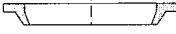
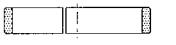
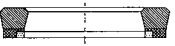
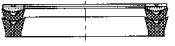

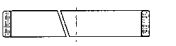
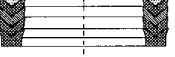
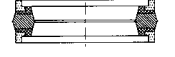
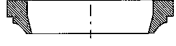
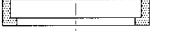
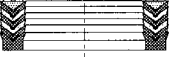
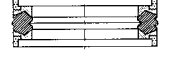
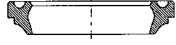
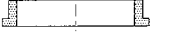
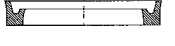
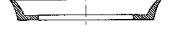

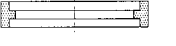
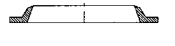
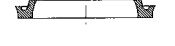
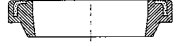
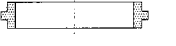
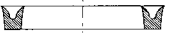

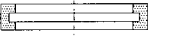
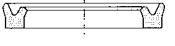
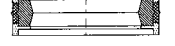

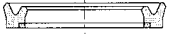
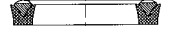
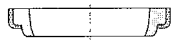
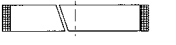
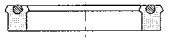
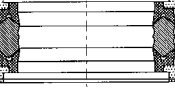
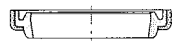
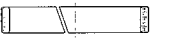

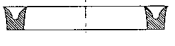
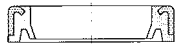
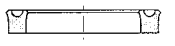

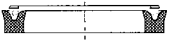
# Seal jet

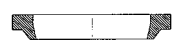
	A1		S1		S17		K1
	A2		S2		S18		K2
	A3		S3		S19		K3
	A4		S4		S20		K4
	A5		S5		S21		K5
	A6		S6		S22		K6
	A7		S7		S23		K7
	A8		S8		S25 S26 S27		K8
	A9		S9		S29 S30 S31		K9
	A10		S10 S11 S12				K10 K11 K12
	A11		S13 S14 S15				K13 K14 K15
	A13		S16				K16

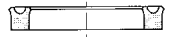
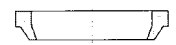
# Seal jet

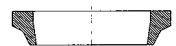
	K17		F1		ST8		R1
	K18		F2		ST9		R2
	K19		F3		ST10		R3
	K20		F4		ST11		R4
	K21		F5		ST12		R5
			F6		ST13		
			F7				R6
							R7
							R8
							R0

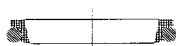
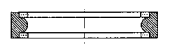
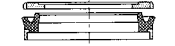
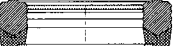
# Polypac

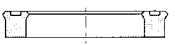
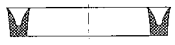
	B		B.../NWO/ KR		DK DK/1		E/DWR I/DWR
	B.../NEI		CH3		DR		E/GTP I/GTP
	CH		D11W		DSR DSR/P		F3
	CH1 CH2		DBM DBM.../M DBM.../SI		DSR.../U		F4
	DDI DDIM		DC DC.../F DC.../P		GA		F5
	DH DH/F DH/P		DDE DDEM		GA.../R		F6
	DU DUM		DPC		NW		F7
	EU EU/I		DPS		PPW		F8
	EU.../NEI		DS DS../NEO		PW.../G		GT E/GT I/GT
	EUS EUS/I		DSM		PW.../U		GTH E/GTH I/GTH
	I/GR		DU DUM		SWP		
	MU		E/GR		UWR UWR/P		
	PDS		EUD		WRM		
	PVA		MU		WRM-P WRM-PI		
	RS.../L		PHD		WRS		
	S19		RSE		WTF		
	S20		RSE.../ W/AR				
	SM		TDO				
	TS		URS URFU				

	0	1"	2"	3"	4"	5"	6"	7"	8"	9"
	millimeters									
<b>0</b>	-	25.400	50.800	76.200	101.600	127.000	152.400	177.800	203.200	228.600
1/64	0.397	25.797	51.197	76.597	101.997	127.397	152.797	178.197	203.597	228.997
1/32	0.794	26.194	51.594	76.994	102.394	127.794	153.194	178.594	203.994	229.394
3/64	1.191	26.591	51.991	77.391	102.791	128.191	153.591	178.991	204.391	229.791
1/16	1.588	26.988	52.388	77.788	103.188	128.588	153.988	179.388	204.788	230.188
5/64	1.984	27.384	52.784	78.184	103.584	128.984	154.384	179.784	205.184	230.584
3/32	2.381	27.781	53.181	78.581	103.981	129.381	154.781	180.181	205.581	230.981
7/64	2.778	28.178	53.578	78.978	104.376	129.778	155.178	180.578	205.978	231.778
1/8	3.175	28.575	53.975	79.375	104.775	130.175	155.575	180.975	206.375	231.375
9/64	3.572	28.972	54.372	79.772	105.172	130.572	155.972	181.372	206.772	232.172
5/32	3.969	29.369	54.769	80.169	105.569	130.969	156.369	181.769	207.169	232.569
11/64	4.366	29.766	55.166	80.566	105.966	131.366	156.766	182.166	207.566	232.966
3/16	4.763	30.163	55.563	80.963	106.363	131.763	157.163	182.563	207.963	233.363
13/64	5.159	30.559	55.959	81.359	106.759	132.159	157.559	182.959	208.359	233.759
7/32	5.556	30.956	56.356	81.756	107.156	132.556	157.956	183.356	208.756	234.156
15/64	5.953	31.353	56.753	82.153	107.553	132.953	158.353	183.753	209.153	234.553
1/4	6.350	31.750	57.150	82.550	107.950	133.350	158.750	184.150	209.550	234.950
17/64	6.747	32.147	57.547	82.947	108.347	133.747	159.147	184.547	209.947	235.347
9/32	7.144	32.544	57.944	83.344	108.744	134.144	159.544	184.944	210.344	235.744
19/64	7.541	32.941	58.341	83.741	109.141	134.541	159.941	185.341	210.741	236.141
5/16	7.938	33.338	58.738	84.138	109.538	134.938	160.338	185.738	211.138	236.538
21/64	8.334	33.734	59.134	84.534	109.934	135.334	160.734	186.134	211.534	236.934
11/32	8.731	34.131	59.531	84.931	110.331	135.731	161.131	186.531	211.931	237.331
23/64	9.128	34.528	59.928	85.328	110.728	136.128	161.528	186.928	212.328	237.728
3/8	9.525	34.925	60.325	85.725	111.125	136.525	161.925	187.325	212.725	238.125
25/64	9.922	35.322	60.722	86.122	111.522	136.922	162.322	187.722	213.122	238.522
13/32	10.319	35.719	61.119	86.519	111.919	137.319	162.719	188.119	213.519	238.919
27/64	10.716	36.116	61.516	86.916	112.316	137.716	163.116	188.516	213.916	239.316
7/16	11.113	36.513	61.913	87.313	112.713	138.113	163.513	188.913	214.313	239.713
29/64	11.509	36.909	62.309	87.709	113.109	138.509	163.909	189.309	214.709	240.109
15/32	11.906	37.306	62.706	88.106	113.506	138.906	164.306	189.706	215.106	240.506
31/64	12.303	37.703	63.103	88.503	113.903	139.303	164.703	190.103	215.503	240.903
1/2	12.700	38.100	63.500	88.900	114.300	139.700	165.100	190.500	215.900	241.300
33/64	13.097	38.497	63.897	89.297	114.697	140.097	165.497	190.897	216.297	241.697
17/32	13.494	38.894	64.294	89.694	115.094	140.494	165.894	191.294	216.694	242.094
35/64	13.891	39.291	64.691	90.091	115.491	140.891	166.291	191.691	217.091	242.491
9/16	14.288	39.688	65.088	90.488	115.888	141.288	166.688	192.088	217.488	242.888
37/64	14.684	40.084	65.484	90.884	116.284	141.684	167.084	192.484	217.884	243.284
19/32	15.081	40.481	65.881	91.281	116.681	142.081	167.481	192.881	218.281	243.681
39/64	15.478	40.878	66.278	91.678	117.078	142.478	167.878	193.278	218.678	244.078
5/8	15.875	41.275	66.675	92.075	117.475	142.875	168.275	193.675	219.075	244.475
41/64	16.272	41.672	67.072	92.472	117.872	143.272	168.672	194.072	219.472	244.872
21/32	16.669	42.069	67.469	92.869	118.269	143.669	169.069	194.469	219.869	245.269
43/64	17.066	42.466	67.866	93.266	118.666	144.066	169.466	194.866	220.266	245.666
11/16	17.463	42.863	68.263	93.663	119.063	144.463	169.863	195.263	220.663	246.063
45/64	17.859	43.259	68.659	94.059	119.459	144.859	170.259	195.659	221.059	246.459
23/32	18.256	43.656	69.056	94.456	119.856	145.256	170.656	196.056	221.456	246.856
47/64	18.653	44.053	69.453	94.853	120.253	145.653	171.053	196.453	221.853	247.253
3/4	19.050	44.450	69.850	95.250	120.650	146.050	171.450	196.850	222.250	247.650
49/64	19.447	44.847	70.247	95.647	121.047	146.447	171.847	197.247	222.647	248.047
25/32	19.844	45.244	70.644	96.044	121.444	146.844	172.244	197.644	223.044	248.444
51/64	20.241	45.641	71.041	96.441	121.841	147.241	172.641	198.041	223.441	248.841
13/16	20.638	46.038	71.438	96.838	122.238	147.638	173.038	198.438	223.838	249.238
53/64	21.034	46.434	71.834	97.234	122.634	148.034	173.434	198.834	224.234	249.634
27/32	21.431	46.831	72.231	97.631	123.031	148.431	173.831	199.231	224.631	250.031
55/64	21.828	47.228	72.628	98.028	123.428	148.828	174.228	199.628	225.028	250.428
7/8	22.225	47.625	73.025	98.425	123.825	149.225	174.625	200.025	225.425	250.825
57/64	22.622	48.022	73.422	98.822	124.222	149.622	175.022	200.422	225.822	251.222
29/32	23.019	48.419	73.819	99.219	124.619	150.019	175.419	200.819	226.219	251.619
59/64	23.416	48.816	74.216	99.616	125.016	150.416	175.816	201.216	226.616	252.016
15/16	23.813	49.213	74.613	100.013	125.413	150.813	176.213	201.613	227.013	252.413
61/64	24.209	49.609	75.009	100.409	125.809	151.209	176.609	202.009	227.409	252.809
31/32	24.606	50.006	75.406	100.806	126.206	151.606	177.006	202.406	227.806	253.206
63/64	25.003	50.403	75.803	101.203	126.603	152.003	177.403	202.803	228.203	253.603

